

bq24702/03 EVM
***for Multi-Chemistry Battery Charge Controller
and System Power Selector***

User's Guide

IMPORTANT NOTICE

Texas Instruments Incorporated and its subsidiaries (TI) reserve the right to make corrections, modifications, enhancements, improvements, and other changes to its products and services at any time and to discontinue any product or service without notice. Customers should obtain the latest relevant information before placing orders and should verify that such information is current and complete. All products are sold subject to TI's terms and conditions of sale supplied at the time of order acknowledgment.

TI warrants performance of its hardware products to the specifications applicable at the time of sale in accordance with TI's standard warranty. Testing and other quality control techniques are used to the extent TI deems necessary to support this warranty. Except where mandated by government requirements, testing of all parameters of each product is not necessarily performed.

TI assumes no liability for applications assistance or customer product design. Customers are responsible for their products and applications using TI components. To minimize the risks associated with customer products and applications, customers should provide adequate design and operating safeguards.

TI does not warrant or represent that any license, either express or implied, is granted under any TI patent right, copyright, mask work right, or other TI intellectual property right relating to any combination, machine, or process in which TI products or services are used. Information published by TI regarding third-party products or services does not constitute a license from TI to use such products or services or a warranty or endorsement thereof. Use of such information may require a license from a third party under the patents or other intellectual property of the third party, or a license from TI under the patents or other intellectual property of TI.

Reproduction of information in TI data books or data sheets is permissible only if reproduction is without alteration and is accompanied by all associated warranties, conditions, limitations, and notices. Reproduction of this information with alteration is an unfair and deceptive business practice. TI is not responsible or liable for such altered documentation.

Resale of TI products or services with statements different from or beyond the parameters stated by TI for that product or service voids all express and any implied warranties for the associated TI product or service and is an unfair and deceptive business practice. TI is not responsible or liable for any such statements.

Mailing Address:

Texas Instruments
Post Office Box 655303
Dallas, Texas 75265

EVM IMPORTANT NOTICE

Texas Instruments (TI) provides the enclosed product(s) under the following conditions:

This evaluation kit being sold by TI is intended for use for **ENGINEERING DEVELOPMENT OR EVALUATION PURPOSES ONLY** and is not considered by TI to be fit for commercial use. As such, the goods being provided may not be complete in terms of required design-, marketing-, and/or manufacturing-related protective considerations, including product safety measures typically found in the end product incorporating the goods. As a prototype, this product does not fall within the scope of the European Union directive on electromagnetic compatibility and therefore may not meet the technical requirements of the directive.

Should this evaluation kit not meet the specifications indicated in the EVM User's Guide, the kit may be returned within 30 days from the date of delivery for a full refund. **THE FOREGOING WARRANTY IS THE EXCLUSIVE WARRANTY MADE BY SELLER TO BUYER AND IS IN LIEU OF ALL OTHER WARRANTIES, EXPRESSED, IMPLIED, OR STATUTORY, INCLUDING ANY WARRANTY OF MERCHANTABILITY OR FITNESS FOR ANY PARTICULAR PURPOSE.**

The user assumes all responsibility and liability for proper and safe handling of the goods. Further, the user indemnifies TI from all claims arising from the handling or use of the goods. Please be aware that the products received may not be regulatory compliant or agency certified (FCC, UL, CE, etc.). Due to the open construction of the product, it is the user's responsibility to take any and all appropriate precautions with regard to electrostatic discharge.

EXCEPT TO THE EXTENT OF THE INDEMNITY SET FORTH ABOVE, NEITHER PARTY SHALL BE LIABLE TO THE OTHER FOR ANY INDIRECT, SPECIAL, INCIDENTAL, OR CONSEQUENTIAL DAMAGES.

TI currently deals with a variety of customers for products, and therefore our arrangement with the user **is not exclusive**.

TI assumes **no liability for applications assistance, customer product design, software performance, or infringement of patents or services described herein**.

Please read the EVM User's Guide and, specifically, the EVM Warnings and Restrictions notice in the EVM User's Guide prior to handling the product. This notice contains important safety information about temperatures and voltages. For further safety concerns, please contact the TI application engineer.

Persons handling the product must have electronics training and observe good laboratory practice standards.

No license is granted under any patent right or other intellectual property right of TI covering or relating to any machine, process, or combination in which such TI products or services might be or are used.

Mailing Address:

Texas Instruments
Post Office Box 655303
Dallas, Texas 75265

EVM WARNINGS AND RESTRICTIONS

It is important to operate this EVM within the input voltage range of 9 V to 20 V and the output voltage range of 7.5 V and 28 V.

Exceeding the specified input range may cause unexpected operation and/or irreversible damage to the EVM. If there are questions concerning the input range, please contact a TI field representative prior to connecting the input power.

Applying loads outside of the specified output range may result in unintended operation and/or possible permanent damage to the EVM. Please consult the EVM User's Guide prior to connecting any load to the EVM output. If there is uncertainty as to the load specification, please contact a TI field representative.

During normal operation, some circuit components may have case temperatures greater than 60°C. The EVM is designed to operate properly with certain components above 60°C as long as the input and output ranges are maintained. These components include but are not limited to linear regulators, switching transistors, pass transistors, and current sense resistors. These types of devices can be identified using the EVM schematic located in the EVM User's Guide. When placing measurement probes near these devices during operation, please be aware that these devices may be very warm to the touch.

Mailing Address:

Texas Instruments
Post Office Box 655303
Dallas, Texas 75265

Copyright © 2003–2005, Texas Instruments Incorporated

Read This First

About This Manual

The bq24702/3 is a highly integrated battery charge controller designed to work with external host commands. It has an integrated PWM charger and system power selector. The charge voltage, charge current, and other system parameters are programmable. For details, see bq24702/3 data sheet (SLUS553)

How to Use This Manual

This document contains the following chapters:

- Chapter 1—Introduction
- Chapter 2—Test Summary
- Chapter 3—Using Additional Functions
- Chapter 4—Example: Configuring bq24702/3 for a 3-Cell Li-Ion Pack
- Chapter 5—Bill of Materials, Board Layout, and Schematics

Information About Cautions and Warnings

This book may contain cautions and warnings.

This is an example of a caution statement.

A caution statement describes a situation that could potentially damage your software or equipment.

This is an example of a warning statement.

A warning statement describes a situation that could potentially cause harm to you.

Related Documentation From Texas Instruments

- bq24702/bq24703 Notebook PC Battery Controller and Selector DPM – SLUS553

FCC Warning

This equipment is intended for use in a laboratory test environment only. It generates, uses, and can radiate radio frequency energy and has not been tested for compliance with the limits of computing devices pursuant to subpart J of part 15 of FCC rules, which are designed to provide reasonable protection against radio frequency interference. Operation of this equipment in other environments may cause interference with radio communications, in which case the user at his own expense will be required to take whatever measures may be required to correct this interference.

Trademarks

The TI Logo is a trademark of Texas Instruments.

Contents

1	Introduction	1-1
1.1	EVM Features	1-2
1.2	Contents	1-2
1.3	Module Electrical Characteristics	1-2
1.4	Optional Components	1-3
2	Test Summary	2-1
2.1	I/O Description	2-2
2.2	Controls and Adjustable Resistors	2-3
2.3	Configuration Procedure	2-4
3	Using Additional Functions	3-1
3.1	System Break-Before-Make	3-2
3.2	External Pullup for ALARM/ACPRES Outputs	3-2
3.3	External Reference for PWM Loop	3-2
4	Example: Configuring bq24702/3 for a 3-Cell Li-Ion Pack	4-1
4.1	Configuration Procedure	4-2
5	Bill of Materials, Board Layout, and Schematics	5-1
5.1	Bill of Materials	5-2
5.2	Board Layout	5-4
5.3	Schematics	5-7

Introduction

The bq24702/3 evaluation module is a complete charger module for evaluating a multi-chemistry charge solution using the bq24702/3 devices. It is designed to deliver up to 3 A of current to Li-Ion applications (3 or 4 cells) and NiMH applications (5–10 cells). Higher current levels can be obtained by utilizing distinct inductor and switches .

The bq24702/3 is a highly integrated battery charge controller designed to work with external host commands. It has an integrated PWM charger and system power selector. The charge voltage, charge current, and other system parameters are programmable. For details, see bq24702/3 data sheet (SLUS553)

Topic	Page
1.1 EVM Features	1-2
1.2 Contents	1-2
1.3 Module Electrical Characteristics	1-2
1.4 Optional Components	1-3

1.1 EVM Features

- Programmable up to 3-A charge current
- Programmable charge voltage, charge current, battery depleted, system break before make, and ac-adaptor detection levels
- Supports single chemistry and multi-chemistry applications
- Status outputs: battery depleted and ac-adaptor detection
- TTL-level controls: charge enable and selector mode

1.2 Contents

- Evaluation module and support documentation

Condition -20°C ≤ T _J ≤ 125°C	Selector Operation	
	bq24702PW	bq24703PW
Battery as Power Source		
Battery removal	Automatically selects ac + alarm	Automatically selects ac + alarm
Battery reinserted	Selection based on selector inputs	
AC as Power Source		
AC removal	Automatically selects battery	Automatically selects battery
AC reinserted	Selection based on selector inputs	Selection based on selector inputs
Depleted Battery Condition		
Battery as power source	Sends ALARM signal	Automatically selects ac Sends ALARM signal
AC as power source	Sends ALARM signal	Sends ALARM signal
Alarm Signal Active		
	Depleted battery condition	Depleted battery condition
	Selector inputs do not match selector outputs	

1.3 Module Electrical Characteristics

- Input adapter voltage: 7.5 V–28 V
- Battery voltage for selector operation: 5 V minimum
- Battery charge current limit: 3 A maximum
- Battery voltage regulation : 9 V minimum, 20 V maximum
- AC adapter current limit: 4 A maximum
- Battery depletion level: 5.0 V minimum
- AC adapter detection: 7.5 V minimum

1.4 Optional Components

The bq24702/3 EVM has all components required for robust operation on a wide range of different operating conditions and ac adapter/load transients. However, some of its components might not be required or can be of distinct value, depending on the application condition. See bq24702/3 data sheet (SLUS553) application notes for details:

Component	When it must be added to app ckt :
D5, D6 (see Note 1)	Negative voltage transients at load
C9	Positive voltage transients at load
D7	U4 power dissipation exceeded when load is powered through U4 backgate diode
C12 value (see Note 2)	V _{CC} line overvoltage when adapter is hot-plugged
D9/D2/R18/R26	Turnon times for battery and ac adapter switches need to be increased
R19 power rating = 1W	Zero volt mode enabled in steady state mode
R11	System break before make must be enabled upon adapter removal
R6	Fast detection of ac adapter removal is needed

- Notes:**
- 1) The EVM components selected for D5/D6 provide protection against large negative spikes on the system and battery terminals. These components can have leakage currents, which can cause offset on the charge current due to voltage drops on SRP/SRN filter resistors. D5/D6 can be removed or replaced by smaller devices depending on the level of protection required against negative transients. See the bq24702/3 data sheet for details. D5 and D6 are not installed on this EVM.
 - 2) This capacitor is always required for PWM ripple current filtering. Value might have to be increased to implement hot-plug event protection.



TEST SUMMARY

This chapter provides details on board configurations.

Topic	Page
2.1 I/O Description	2-2
2.2 Controls and Adjustable Resistors	2-3
2.3 Configuration Procedure	2-4

2.1 I/O Description

Jack	Description
J1-POS	AC adapter, positive output
J1-GND	AC adapter, negative output
J2-VPUP	ALARM/ACPRES pullup input voltage
J2-5V	Internal 5-V reference output voltage
J5-ACPRES	ACPRES pin output voltage (ac detection)
J5-ALARM	ALARM pin output voltage (battery depleted)
J5-GNDSNS	Kelvin GND connection to EVM clean ground plane
J5-SRSET (see Note 3)	Charge current limit setting (see Note)
J5-ACSET (see Note 3)	DPM current limit current setting (see Note)
J6-IBAT	Charge current translator positive output
J6-GND_SNS	Kelvin GND connection to IC ground pin
J6-EXTREF	Charge voltage external reference positive input
J8-VSYS	Positive output to system
J8-VBAT	Battery pack+ connection
J8-GND	Negative output to system, battery pack - connection
J10-LED5V	5-V external supply for LED's, positive output
J10-LEDGND	External supply for LED's, negative output

Notes: 3) A resistive divider powered from 5-V internal reference sets the voltage at those pins. An external voltage connected to those pins can be used to set current limits; if that mode is preferred remove resistors R9/R7 from EVM and make sure that R8/R10 are not set to zero, in order to avoid short between external supply and GND.

2.2 Controls and Adjustable Resistors

Jack	Description	Factory Setting
J3	Charge control, ON at charge disabled	Charge disabled
J4	System power selector configuration, ON at battery connected to system	AC adapter to system
J7	Charge voltage reference 1-2 at external reference 2-3 at internal reference	Internal reference selected
J9	System break before make function, ON at function disabled	System break before make function enabled

Resistor	Description	Factory Setting
R8	AC adapter current limit setting. $IDPM = \frac{V(ACSET)}{25}$ (25e-3)	ACSET = 1.875 V IDPM = 3 A
R10	Charge current limit $ICHG = \frac{V(SRSET)}{25}$ (25e-3)	SRSET = 1.25 V ICHG = 2 A
R12	AC detection threshold $ACDET = 1.22 \times (100 + R12)/R12$ R12 in k Ω	ACDET = 16 V
R23	Battery depleted threshold $BATD = 1.22 \times (R23 + 604)/R23$ R23 in k Ω	BATD = 9 V
R25	Charge voltage $VCHG = 1.25 \times \frac{(R25 + 648.2)}{(R25 + 44.2)}$ R25 in k Ω	VCHG = 12.60 V
R28	System break before make $V(BATP) = V(VS)$ at $VSYS = VSYSB$	VSYSB = 12.60 V
R6/R11	AC adapter sense input voltage	R11 open, R6 = 100 k. Sensing directly the ac adapter voltage (POS)

2.3 Configuration Procedure

This procedure details how to configure the evaluation board, using the EVM as a stand-alone unit, in case the factory settings have to be modified. The board was originally configured as shown in section 2.2. External power sources (20 V, 3 A) , battery pack, 100- Ω /5-W resistor and current load are required to evaluate the board. This configuration uses the internal reference and has the system voltage break-before-make disabled. The ACPRES and ALARM EVM pullup resistors are connected to the bq24702/3 5-V reference.

Naming conventions are as follows :

- XXX = EVM terminal
- V(XXX) = Voltage at EVM terminal XXX
- V(TPyyy) = Voltage at test point TPyyy
- Jxx ON = Jumper terminals are shorted
- Jxx OFF = Jumper terminals are open
- V(XXX)=V(YYY) \rightarrow Voltage at node XXX and voltage at node YYY are within ± 20 mV

If a visual status display for ac detection and ALARM is desired, set J2 OFF and connect an external 5-V supply to J10 as follows:

- Positive terminal to VPUP (J2) and LED5V (J10)
- Negative terminal to LEDGND (J10)

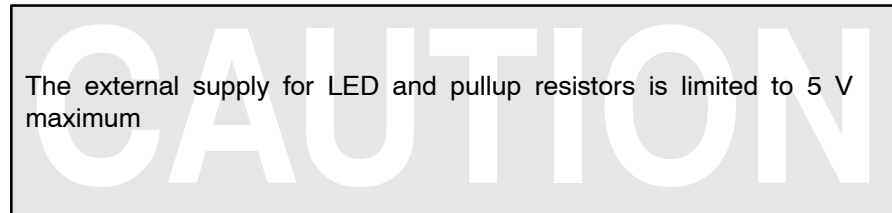

The following settings are used for all configuration steps, unless otherwise stated :

- J2 ON \rightarrow Pullup to internal 5-V regulated voltage enabled
- J7 2-3 ON \rightarrow Use internal reference for charge voltage loop.
- J9 ON \rightarrow System break-before-make disabled.

Configuration steps:

Step 1: Adjust AC Detection Threshold

Set jumpers as follows → J3 ON (charge off)
J4 OFF (ac adapter to system)

- 1) VBAT (J8) open. Connect external supply set to 0 V to J1 (POS/GND), connect 100-Ω resistor between J8 VSYS/GND.
- 2) Increase supply voltage to desired ac-detection threshold.

CAUTION
Make sure that ac detection threshold is at least 1 V above target charge voltage. The external supply connected to J1 (POS/GND) must be able to supply the inrush current required to charge capacitive loads connected to VSYS to avoid ringing during initial VSYS power up.

- 3) Adjust R12 to obtain $V(TP2)=1.23$ V.
- 4) Cycle the external supply power connected to POS from 2 V below to 2 V above programmed ac detection threshold.

Verify → ACPRES toggling, $V(ACPRES)=5$ V when ac is detected, $V(ACPRES) = 0$ V when ac is not detected.

Verify: → VSYS voltage, $V(VSYS)=V(TP1)$ when ac adapter is detected, $V(VSYS) = 0$ V when ac adapter is not detected.

Note: The discharge time for C9 when ac is not detected is set by load at VSYS, C9 value and initial VPOS voltage value.

Step 2: Adjust Battery Depleted Threshold

Set jumpers as follows → J3 ON (charge off)
J4 OFF (ac adapter to system)

1) Connect external supply set above ac-detection threshold programmed in 1) to J1 (POS/GND). Connect 100-Ω resistor between J8 VSYS/GND. Connect external supply set to 0 V to J8 (VBAT/GND). Connect supply to POS, set to voltage above programmed ac-detection level.

2) Increase supply connected to VBAT to desired battery depleted voltage.

3) Adjust R23 until $V(TP11) = 1.23\text{ V}$

4) Cycle the external supply power connected to VBAT from 2 V below to 2 V above programmed battery depleted threshold.

Verify → ALARM toggling, $V(ALARM) = 5\text{ V}$ when battery is depleted, $V(ALARM) = 0\text{ V}$ when battery is not depleted.

→ $V(VSYS) = V(TP1)$

5) Set $V(VBAT)$ above battery depleted threshold, set jumper J4 ON (battery to system).

Verify → Selector connects battery to system,
 $V(VBAT) = V(VSYS)$.

6) Set J4 OFF (AC adapter to system).

Verify → Selector connects ac adapter to system
 $V(POS) = V(TP1)$.

7) Set $V(VBAT)$ above programmed battery depleted threshold. Cycle the external supply power connected to POS from 2 V below to 2 V above programmed ac adapter detection threshold.

Verify → $V(VSYS) = V(TP1)$ when ac adapter is detected.
→ $V(VSYS) = V(VBAT)$ when ac adapter is not detected.

8) With J4 ON (battery to system) and VBAT set above battery depleted threshold remove supply connected to POS.

Verify → $V(VBAT) = V(VSYS)$

9) Cycle the external supply power connected to VBAT from 2 V below to 2 V above programmed battery depleted threshold.

Verify → $V(VBAT) = V(VSYS)$

Step 3: Current Limit Setting

Set jumpers as follows → J3 ON (charge off)
J4 OFF (ac adapter to system)

- 1) Connect external supply set above ac detection threshold programmed in 1) to J1 (POS/GND).
- 2) Adjust R10 monitoring V(SRSET) to program the charge current limit:

Note: $ICHG (typ) = [V(SRSET) / 25] / (0.025)$

- 3) Adjust R8 monitoring V(ACSET) to program the ac adapter current limit:

Note: $IDPM (typ) = [V(ACSET)/25] / (0.025)$

Make sure that $IDPM > ICHG$

CAUTION

Step 4: Charge Voltage Setting

Set jumpers as follows → J3 ON (charge off)
J4 OFF (ac adapter to system)

- 1) Connect external supply set to the desired battery charge voltage to J8, between VBAT and GND. V(VPOS) = open, no load at VSYS.
- 2) Adjust R25 until $V(TP14) = 1.196 V$
- 3) Connect external supply set above ac detection threshold programmed in 1) to J1 (POS/GND). V(VBAT) = open, no load at VSYS.
- 4) Set J3 OFF (charge enabled).

Verify → $V(VBAT) = \text{programmed charge regulation voltage}$
→ $V(VSYS) = V(TP1)$

- 5) Set J3 ON (charge disabled), connect to VBAT a pack with voltage above battery depleted threshold and at least 2 V below the charge regulation threshold.
- 6) Set J3 OFF (charge enabled).

Verify → $I(VBAT) = ICHG$ (battery fast charge current)
→ $I(VBAT) = V(IBAT) / (20 \times 0.025)$

Note: Use ground sense connection in J6 as a reference for V(IBAT) measurement. To avoid measurement errors take precautions to ensure that no common noise mode (PWM radiated noise) is coupled into the measurement setup probes/cables.

- 7) Set J3 ON (charge disabled).

Verify → Charge is off, $I(\text{VBAT}) < 0$ (battery sourcing current)
→ AC adapter switched to VSYS, $V(\text{TP1}) = \text{VSYS}$

- 8) Set J3 OFF (charge enabled) and J4 ON (battery to system).

Verify → Charge is off
→ Battery switched to VSYS, $V(\text{VBAT}) = V(\text{VSYS})$

- 9) J4 OFF (ac adapter to system); connect electronic load to VSYS, increase load from zero to a value greater than $[I(\text{DPM}) - I(\text{CHARGE})]$

Verify → Charge current, $I(\text{VBAT})$ decreases when adapter current $I(\text{VPOS})$ reaches adapter current limit threshold, $I(\text{DPM})$

→ $I(\text{VBAT}) = \text{zero}$ when $I(\text{VSYS}) > I(\text{DPM})$

→ $I(\text{VBAT}) = I(\text{CHARGE})$ when VSYS load is removed

Care must be taken to avoid exceeding the power dissipation ratings for devices D1 and U2; this can be caused by excessive load current. The DPM loop reduces the charge current only; note that the ac adapter supplies as much current as required by the load until the internal ac adapter over-current protection is activated.

Step 5: Zero Volt Charging Function

Set jumpers as follows → J3 ON (charge off)
J4 OFF (ac adapter to system)

- 1) Connect external supply set above ac detection threshold programmed in 1) to J1 (POS/GND), $V(\text{VBAT})$ open, $V(\text{VSYS})$ open
- 2) Connect external load (100 Ω , 5 W) to J8 between VBAT and GND.
- 3) Set J3 ON (charge enabled)

Verify → Minimum value for $V(\text{TP8})$: $V(\text{TP8}) = V(\text{TP1}) \times [1 - (8/850)]$

→ Minimum value for $V(\text{VBAT})$: $V(\text{TP8}) \times (100/850)$

→ $V(\text{IBAT}) = 0 \text{ V}$ (IBAT amplifier is disabled)

→ $V(\text{ALARM}) = 5 \text{ V}$

When running this test make sure that power ratings for R19 are not exceeded (steady state: 1 W max) ! The 0-V operation mode current can be adjusted by modifying the value of resistor R19. Note that $R19 = R21$ to avoid errors on the charge current limit.

Using Additional Functions

This chapter describes the use of the break-before-make function (VS pin).

Topic	Page
3.1 System Break-Before-Make	3-2
3.2 External Pullup for ALARM/ACPRES Outputs	3-2
3.3 External Reference for PWM Loop	3-2

3.1 System Break-Before-Make

The system break-before-make function (VS pin) can be enabled by:

→ Setting J9 open (break-before-make enabled).

The configuration procedure to set the break-before-make threshold is as follows:

- 1) Connect power supply to J8 between VBAT and GND. V(POS) (J1) open
- 2) Adjust VBAT = programmed break-before-make threshold
- 3) Adjust R28 until $V(TP17) = 1.196 \text{ V}$.

Note: The above procedure enables switching from battery to system when the system voltage is equal to or less than the battery voltage. See bq24702/3 data sheet application notes section for additional information on break-before-make functionality when sensing directly the ac adapter voltage.

3.2 External Pullup for ALARM/ACPRES Outputs

The external pullup can be enabled by:

→ J2 OFF

→ Connecting external supply between J2 (5V) and J1 (GND).

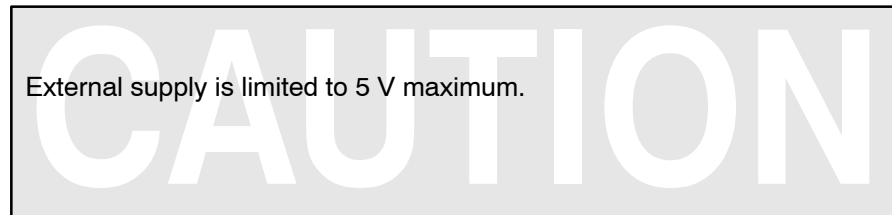

3.3 External Reference for PWM Loop

An external reference can be used for the PWM voltage loop:

→ J7: 1– 2

→ Connect external reference between J6 (EXTREF) and J6 (GND_SNS)

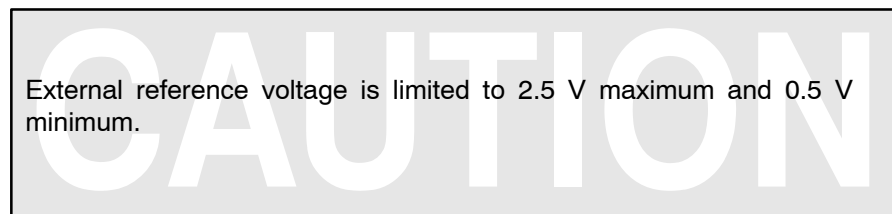

Example: Configuring bq24702/3 for a 3-Cell Li-Ion Pack

This chapter describes the configuring the bq24702/3 for a 3-cell Li-Ion Pack.

Design parameters:

Charge current limit = 2 A

DPM current limit = 3 A

AC adapter threshold = 16 V

Battery depleted threshold = 9 V

System break-before-make threshold equal to pack voltage

Topic	Page
4.1 Configuration Procedure	4-2

4.1 Configuration Procedure

Step 1: Adjust AC Detection Threshold

Set jumpers as follows → J3 ON (charge off)
J4 OFF (ac adapter to system)

- 1) VBAT (J8) open. 100-Ω resistor between J8 VSYS/GND, V(POS) = 16 V.
- 2) Adjust R12 to obtain $V(TP2) = 1.23 \text{ V} \pm 1 \text{ mV}$.
- 3) $V(POS) = 14 \text{ V}$, *Measure* → $V(ACPRES) = 0 \text{ V}$, $V(VSYS) = 0 \text{ V}$
 $V(POS) = 18 \text{ V}$, *Measure* → $V(ACPRES) = 5 \text{ V} \pm 5 \text{ mV}$,
 $V(VSYS) = V(TP1) \pm 20 \text{ mV}$

Step 2: Adjust Battery Depleted Threshold

Set jumpers as follows → J3 ON (charge off)
J4 OFF (ac adapter to system)

- 1) $V(POS) = 18 \text{ V}$. Connect 100-Ω resistor between J8 VSYS/GND. $V(VBAT) = 9 \text{ V}$
- 2) Adjust R23 $V(TP11) = 1.23 \text{ V} \pm 1 \text{ mV}$
- 3) $V(VBAT) = 7 \text{ V}$, *Measure* → $V(ALARM) = 0 \text{ V}$, $V(VSYS) = V(TP1)$
 $V(VBAT) = 11 \text{ V}$, *Measure* → $V(ALARM) = 5 \text{ V} \pm 5 \text{ mV}$
 $V(VSYS) = V(TP1) \pm 20 \text{ mV}$
- 4) $V(VBAT) = 11 \text{ V}$, J4 ON (batt to system),
Measure: → $V(VSYS) = V(VBAT) \pm 20 \text{ mV}$.
- 5) Set J4 OFF (ac adapter to system),
Measure: → $V(POS) = V(TP1) \pm 20 \text{ mV}$.
- 6) $V(VBAT) = 11 \text{ V}$, $V(POS) = 14 \text{ V}$,
Measure: → $V(VSYS) = V(VBAT) \pm 20 \text{ mV}$
 $V(VBAT) = 11 \text{ V}$, $V(POS) = 18 \text{ V}$,
Measure: → $V(VSYS) = V(TP1) \pm 20 \text{ mV}$
- 7) J4 ON (battery to system), $V(VBAT) = 11 \text{ V}$, $V(POS)$ open
Measure: → $V(VSYS) = V(VBAT) \pm 20 \text{ mV}$
- 8) $V(VBAT) = 7 \text{ V}$ *Measure*: → $V(VSYS) = V(VBAT) \pm 20 \text{ mV}$

Step 3: Current Limit Setting

Set jumpers as follows → J3 ON (charge off)
J4 OFF (ac adapter to system)

- 1) $V(POS) = 18 \text{ V}$
- 2) Adjust R10 to set $V(SRSET) = 1.25 \text{ V} \pm 5 \text{ mV}$
- 3) Adjust R8 to set $V(ACSET) = 1.875 \text{ V} \pm 5 \text{ mV}$

Step 4: Charge Voltage Setting

Set jumpers as follows → J3 ON (charge off)

J4 OFF (ac adapter to system)

1) $V(\text{VBAT}) = 12.6 \text{ V}$, $V(\text{VPOS}) = \text{open}$, no load at VSYS.

2) Adjust R25 until $V(\text{TP14}) = 1.196 \text{ V} \pm 1 \text{ mV}$

3) $V(\text{POS}) = 18 \text{ V}$, $V(\text{VBAT}) = \text{open}$, no load at VSYS.

4) Set J3 OFF (charge enabled).

Measure: → $V(\text{VBAT}) = 12.6 \text{ V} \pm 70 \text{ mV}$

→ $V(\text{VSYS}) = V(\text{TP1}) \pm 20 \text{ mV}$

5) Set J3 ON (charge disabled)

6) Connect to VBAT pack with open voltage = 10 V

7) Set J3 OFF (charge enabled).

Measure: → $I(\text{VBAT}) = 2 \text{ A} \pm 120 \text{ mA}$

→ $V(\text{IBAT}) = [I(\text{VBAT}) \times 0.5] \pm 10\%$

Note: Use ground sense connection in J6 as a reference for $V(\text{IBAT})$ measurement. To avoid measurement errors, take precautions to ensure that no common noise mode (PWM radiated noise) is coupled into the measurement setup probes/cables.

8) J3 ON (charge disabled). *Measure:* → $0 < I(\text{VBAT}) < -200 \mu\text{A}$
→ $V(\text{TP1}) = \text{VSYS} \pm 20 \text{ mV}$

9) J3 OFF (charge enabled), J4 ON (battery to system).

Measure: → $-1 \text{ mA} < I(\text{VBAT}) < -6 \text{ mA}$

→ $V(\text{VBAT}) = V(\text{VSYS}) \pm 20 \text{ mV}$

10) Connect electronic load to VSYS, J4 OFF (ac adapter to system)

Measure: → $I(\text{VBAT}) < 1 \text{ A} \pm 0.3 \text{ A}$ at $I(\text{VSYS}) = 2 \text{ A}$

→ $I(\text{VBAT}) = \text{zero}$ at $I(\text{VSYS}) = 3.2 \text{ A}$

11) Remove electronic load from VSYS,

Measure → $I(\text{VBAT}) = 2 \text{ A} \pm 0.2 \text{ A}$

Step 5: Zero Volt Charging Function

Set jumpers as follows → J3 ON (charge off)

J4 OFF (ac adapter to system)

1) $V(\text{POS}) = 18 \text{ v}$, $V(\text{VBAT})$ open, $V(\text{VSYS})$ open

2) Connect external load (100 Ω , 5 W) to J8 between VBAT and GND.

3) Set J3 OFF (charge enabled).

Measure: → $[V(\text{TP1}) - 180 \text{ mV}] < V(\text{TP8}) < [V(\text{TP1}) - 140 \text{ mV}]$

→ $V(\text{VBAT}) = [V(\text{TP8}) * (100/850)] \pm 2\%$

→ $V(\text{IBAT}) = 5 \text{ mV}$ maximum

→ $V(\text{ALARM}) = 5 \text{ V} \pm 5 \text{ mV}$

Step 6: System Break-Before-Make

Set jumpers as follows → J3 ON (charge off)
J4 OFF (ac adapter to system)

- 1) J9 open (break-before-make enabled)
- 2) V(POS) = 18 V, V(VBAT) = 12.6 V ±1 mV, no load at VSYS
- 3) Adjust R28 until V(TP17) = 1.196 V
- 4) J4 ON, *Measure:* → V(VSYS)–V(VBAT) < 100 mV at V(VCC,TP16) > 5 V

Note: When V(POS) is set to open, the capacitor at VSYS holds the voltage and slowly discharges. The discharge current is basically the IC quiescent current. The total discharge time should be a few seconds. Use an oscilloscope triggered by the falling edge of TP16 to measure break-before-make threshold.

Step 7: External Reference

Set jumpers as follows → J3 ON (charge off)
J4 OFF (ac adapter to system)

- 1) J7: 1-2 , V(POS) = 18 V, V(VBAT) open, no load at VSYS, V(EXTREF) = 1.196 V
- 2) J3 OFF (charge on)
- 3) *Measure:* → V(VBAT) = 12.6 V ±70 mV
- 4) V(EXTREF) = 1.5 V, *Measure:* → V(VBAT) = 15.8 V

Bill of Materials, Board Layout, and Schematics

Topic	Page
5.1 Bill of Materials	5-2
5.2 Board Layout	5-4
5.3 Schematics	5-7

5.1 Bill of Materials

COUNT	RefDes	DESCRIPTION	SIZE	MFR	PART NUMBER
2	C1, C5	Capacitor, tantalum, 4.7 μ F, 16 V, 20%	TANTALUM-A	Panasonic	ECS-T1EX475R
1	C10	Capacitor, ceramic, 180 pF, 50 V, X7R, 10%	805	Kemet	C0805C181J5GACTU
1	C11	Capacitor, aluminum, 22 μ F, 35 V, 20%, FC Series	0.335 \times 0.374	Panasonic	EEVFC1V220P
1	C13	Capacitor, ceramic, 0.001 μ F, 50 V, X7R, 10%	805	Kemet	C0805C102M5RACTU
1	C3	Capacitor, ceramic, 1 μ F, 16 V, X7R, 10%	1206	Kemet	C1206C105K4RACTU
1	C4	Capacitor, ceramic, 150 pF, 50 V, X7R, 10%	805	Kemet	C0805C151J5GACTU
1	C6	Capacitor, ceramic, 1.0 μ F, 16 V, X7R, 10%	805	Kemet	C0805C105K4RACTU
3	C7, C8, C14	Capacitor, ceramic, 0.1 μ F, 50 V, X7R, 10%	805	Kemet	C0805C104K5RACTU
2	C9, C12	Capacitor, aluminum, SM, 220 μ F, 35 V, 150 m Ω , FC series	10 \times 12 mm	Panasonic	EEV-FC1V221P
3	D1, D4, D7	Diode, dual Schottky, 6 A, 40 V	DPAK	On Semi	MBRD640CTT4
1	D11	Diode, LED, green, 20 mA, 0.9 mcd	0.068 \times 0.049	Panasonic	LN1371G-(TR)
2	D12	Diode, LED, red, 20 mA, 0.9 mcd	0.068 \times 0.049	Panasonic	LN1271R-(TR)
2	D2, D9	Diode, switching, 10 mA, 85 V, 350 mW	SOT23	Vishay-Liteon	BAS16
1	D3	Diode, Zener, 13 V, 19 mA, 350 mW	SOT23	Diode Inc	MMBZ5243B-7
2	D5, D6	Diode, Schottky barrier rectifier, 3 A, 20 V	SMA	Diodes	B330A
2	D8, D10	Diode, Zener, 18 V, 19 mA, 350 mW	SOT23	Diodes Inc	MMBZ5248B-7
1	J1	Terminal block, 2 pin, 6 A, 3,5 mm	75525	OST	ED1514
5	J2, J3, J4, J9, J10	Header, 2 pin, 100 mil spacing, (36-pin strip)	0.100 \times 2	Sullins	PTC36SAAN
1	J5	Header, 5 pin, 100 mil spacing, (36-pin strip)	0.100 \times 5	Sullins	PTC36SAAN
2	J6, J7	Header, 3 pin, 100 mil spacing, (36-pin strip)	0.100 \times 3	Sullins	PTC36SAAN
1	J8	Terminal block, 3 pin, 6 A, 3,5 mm	0.41 \times 0.25	OST	ED1515
1	L1	Inductor, SMT, 33 μ H, 3 A, 50 m Ω	0.472 sq	Sumida	CDRH127-330
2	Q1, Q2	MOSFET, N-ch, 60 V, 115 mA, 1.2 Ω	SOT23	Vishay-Liteon	2N7002DICT
1	R1	Resistor, chip, 0 Ω , 1/8 W	1206	Std	Std
0	R11	Resistor, chip, OPEN, 1/10 W, 1%	805	Std	Std
3	R13, R15, R16	Resistor, chip, 100 Ω , 1/10 W, 1%	805	Std	Std
2	R14, R20	Resistor, chip, 0.025 Ω , 1/2 W, 1%	2010	Vishay-Dale	WSL2010.025+/-1%

COUNT	RefDes	DESCRIPTION	SIZE	MFR	PART NUMBER
1	R17	Resistor, chip, 0.00 Ω , 1/10-W	805	Std	Std
1	R18	Resistor, chip, 10, 1/10-W, 5%	805	Std	Std
1	R19	Resistor, chip, 750 Ω , 1W, 5%	2512	Vishay	CRCW2512751J
8	R2, R3, R4, R5, R6, R7, R9, R26	Resistor, chip, 100 K, 1/10-W, 1%	805	Vishay	CRCW0805-1003-F
1	R21	Resistor, chip, 750 Ω , 1/10W, 1%	805	Vishay	CRCW0603-7500-F
3	R22, R24, R27	Resistor, chip, 604 k Ω , 1/10 W, 1%	805	Vishay	CRCW0805-6043-F
1	R29	Resistor, chip, 30 K, 1/10 W, 1%	805	Std	Std
1	R30	Resistor, chip, 44.2 k Ω , 1/10 W, 1%	805	Vishay	TNPW08054422B
2	R31, R32	Resistor, chip, 2 k Ω , 1/10 W, 5%	805	Std	Std
1	R12	Potentiometer, 20 K, 1/4 cermet	Top-Adjust	Bourns	3266W-203
3	R8, R10, R25	Potentiometer, 100 K, 1/4 cermet	Top-Adjust	Bourns	3266W-104
2	R23, R28	Potentiometer, 200 K, 1/4 cermet	Top-Adjust	Bourns	3266W-204
6	TP1, TP2, TP8, TP11, TP14, TP17	Jack, test point, cir		Farnell	240-345
1	U1	IC, battery charge controller/ selector with DPM	QFN-28	TI	bq24703RHD
3	U2, U3, U4	MOSFET, P-ch, 30 V, 8.0 A, 20 m Ω	SO8	Siliconix	Si4435DY
1	--	PCB, 4.75 In \times 3.4 In \times 0.062 In		Any	HPA093

- Notes:**
- 1) These assemblies are ESD sensitive, ESD precautions shall be observed.
 - 2) These assemblies must be clean and free from flux and all contaminants. Use of no clean flux is not acceptable.
 - 3) These assemblies must comply with workmanship standards IPC-A-610 Class 2.
 - 4) Reference designators marked with an asterisk (***) cannot be substituted. All other components can be substituted with equivalent MFG's components.

5.2 Board Layout

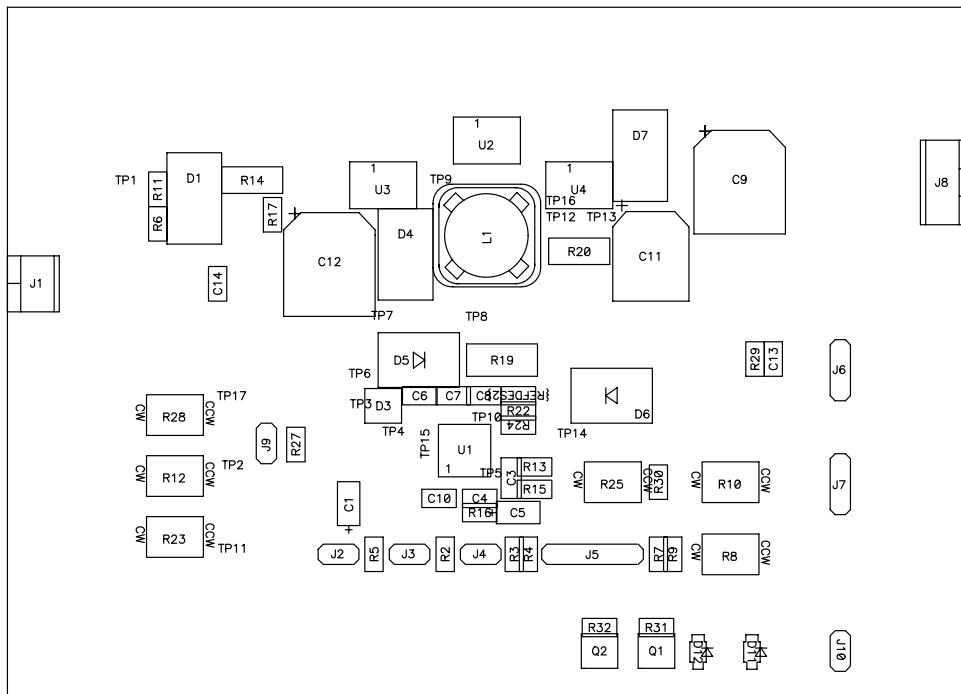

Top Assembly

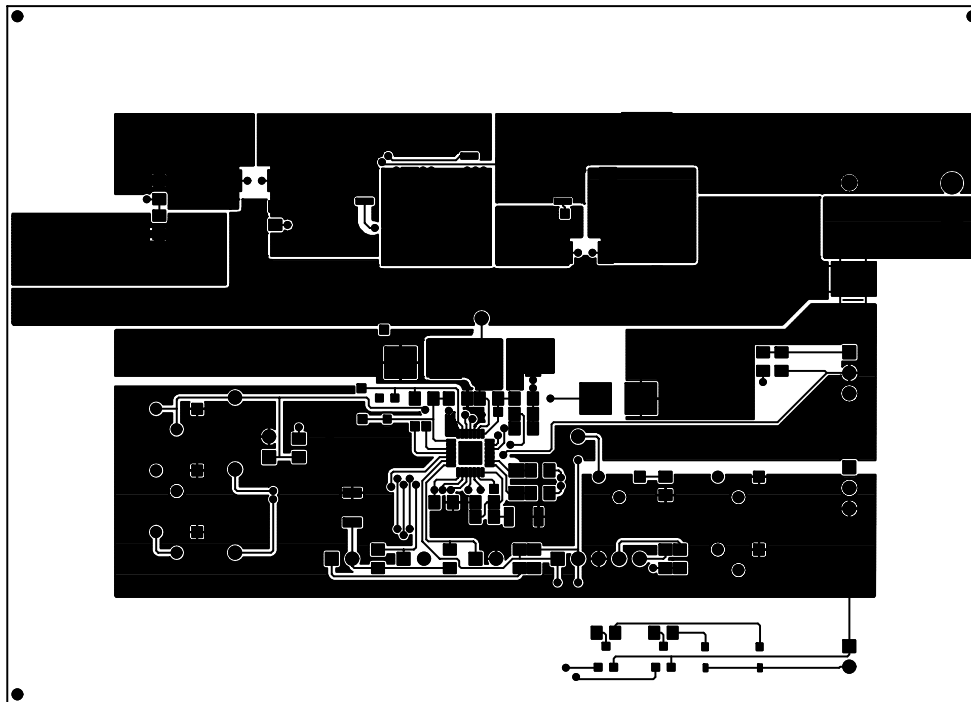

Layer 1

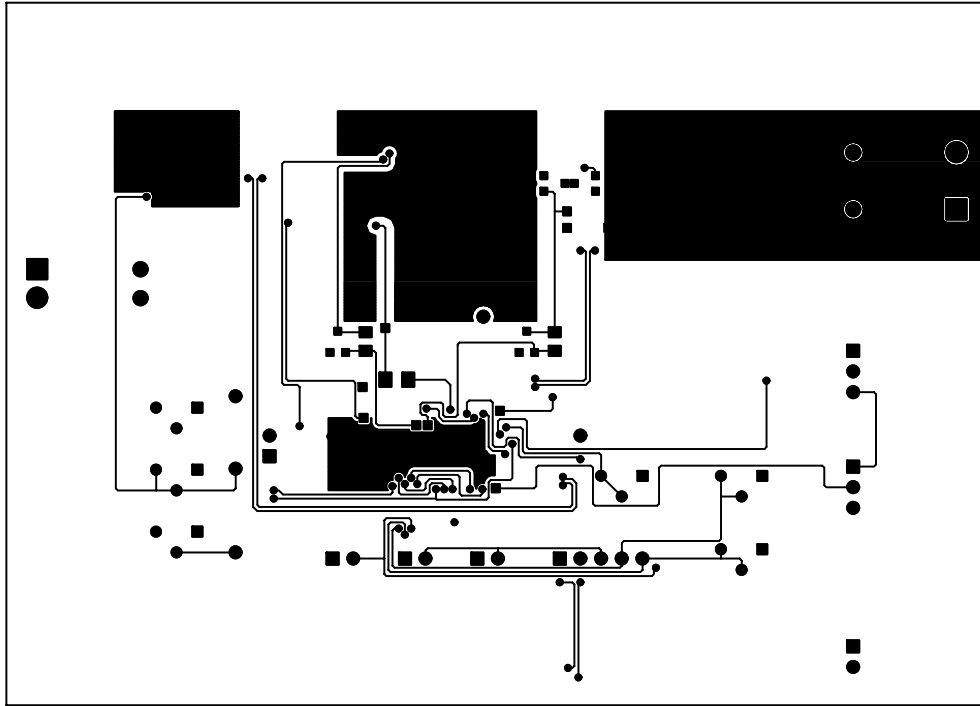

Layer 2

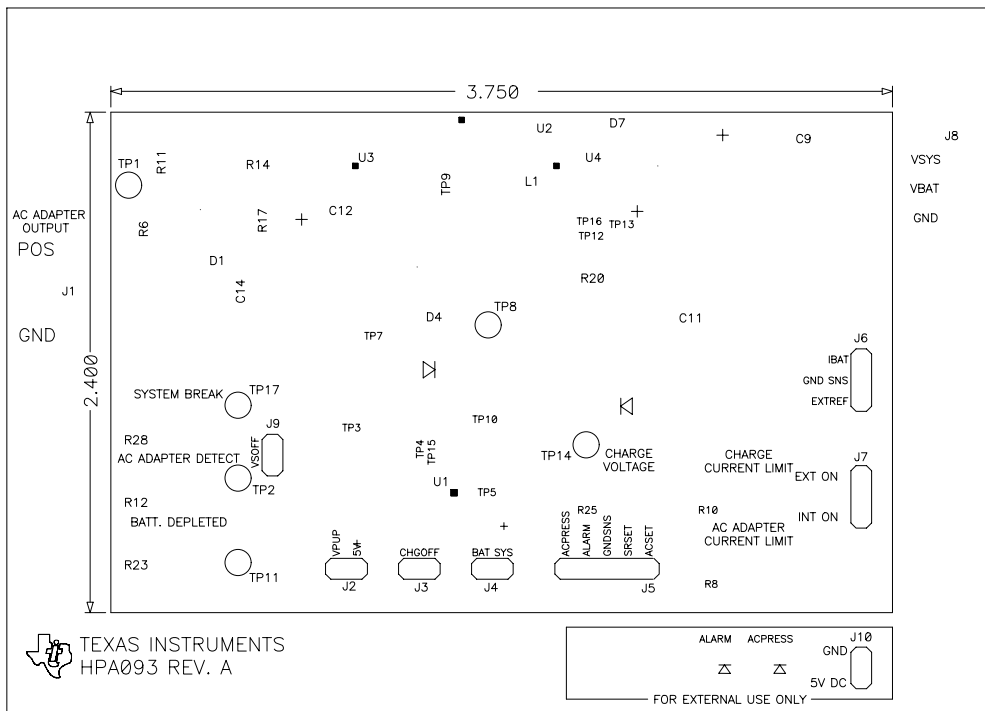

Silk Screen

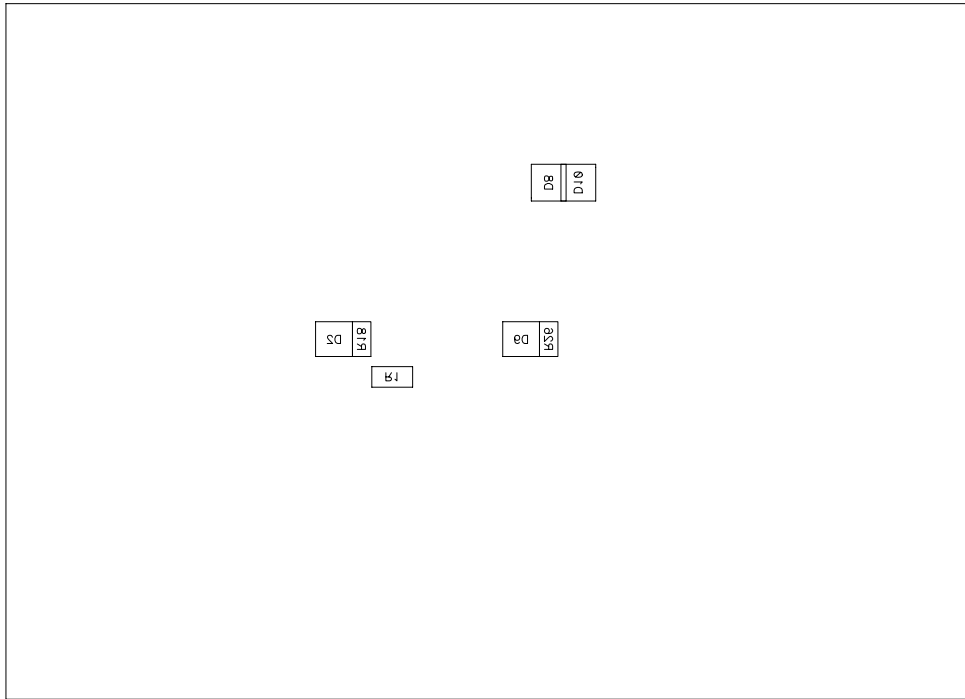

HPA93 REV. A BOTTOM ASSY

Bottom Assembly Reverse

5.3 Schematics

The schematic is shown on the following page.

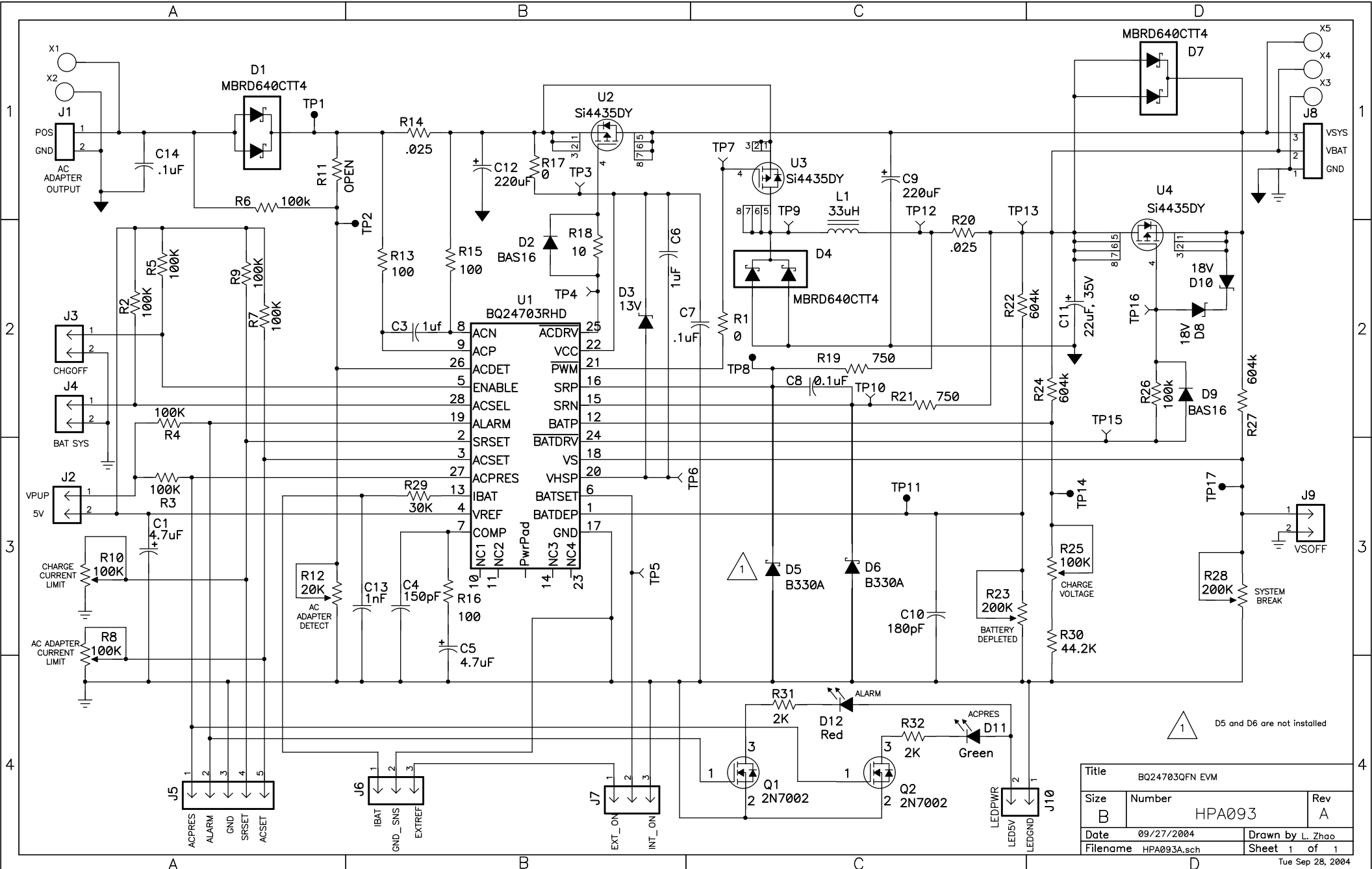

1 D5 and D6 are not installed

Title			BQ24703FN EVM		
Size	Number	HPA093		Rev	A
Date	09/27/2004		Drawn by L. Zhao		
Filename	HPA093A.sch		Sheet 1 of 1		