

## TPS54295 集成 FET 的 2A 双通道同步降压开关

### 1 特性

- D-CAP2™控制模式
  - 快速瞬态响应
  - 环路补偿无需外部部件
  - 与陶瓷输出电容兼容
- 宽输入电压范围：4.5V 至 18V
- 输出电压范围：0.76V 至 7V
- 高效集成场效应晶体管 (FET) 针对低占空比进行了优化应用
  - 150mΩ (高侧) 和 100mΩ (低侧)
- 高初始基准精度
- 低侧  $r_{DS(ON)}$  无损耗电流感测
- 可调节软启动
- 非灌电流预偏置软启动
- 700kHz 开关频率
- 逐周期过流限制控制
- 过流限制 (OCL)、过压保护 (OVP)、欠压保护 (UVP)、欠压锁定 (UVLO) 和热关断 (TSD) 保护
- 集成升压 P 沟道金属氧化物半导体 (PMOS) 开关的自适应栅极驱动
- 凭借温漂为 4000ppm/°C 的热补偿  $r_{DS(ON)}$ , OCP 恒定不变
- 16 引脚散热薄型小外形尺寸 (HTSSOP) 封装, 16 引脚超薄四方扁平无引线封装 (VQFN)
- 自动跳跃 Eco-mode™模式, 以在轻负载时实现高效率

### 2 应用范围

- 低功耗系统中的负载点调节, 广泛适用于各种应用
  - 数字电视电源
  - 网络家庭终端设备
  - 数字机顶盒 (STB)
  - DVD 播放器和录像机
  - 游戏控制台和其他设备

### 3 说明

TPS54295 是一款双路自适应导通时间 D-CAP2 模式同步降压转换器。TPS54295 有助于系统设计人员通过具备成本效益、所用组件较少并且待机电流较低的解决方案完成各种终端设备的电源总线调节器集。

TPS54295 的主控制回路采用 D-CAP2 模式控制, 无需外部补偿元件即可实现快速瞬态响应。自适应接通时间控制可在更高负载状态下的脉宽调制 (PWM) 模式与轻负载下的 Eco-mode 工作之间实现无缝转换。Eco-mode 使 TPS54295 能够在轻载状况下保持高效率。TPS54295 既能够适应诸如高分子有机半导体固体电容 (POSCAP) 或高分子聚合物电容 (SP-CAP) 的低等效串联电阻 (ESR) 输出电容, 也能够适应超低等效串联电阻 (ESR) 的陶瓷电容。该器件在输入电压介于 4.5V 至 18V 范围内时实现便捷高效的运行。

TPS54295 采用 4.4mm x 5mm 16 引脚 HTSSOP (PWP) 封装以及 4mm x 4mm 16 引脚 VQFN (RSA) 封装, 设计为在 -40°C 至 85°C 的环境温度范围内运行。

#### 器件信息(1)

| 器件型号     | 封装          | 封装尺寸 (标称值)      |
|----------|-------------|-----------------|
| TPS54295 | HTSSOP (16) | 5.00mm x 4.40mm |
|          | VQFN (16)   | 4.00mm x 4.00mm |

(1) 要了解所有可用封装, 请见数据表末尾的可订购产品附录。

#### 负载瞬态响应

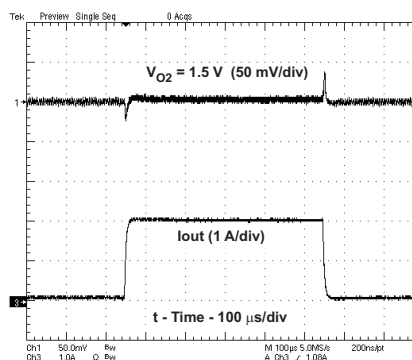

## 目录

|          |  |           |           |   |           |
|----------|--|-----------|-----------|---|-----------|
| <b>1</b> | <b>特性</b> .....                              | <b>1</b>  | <b>8</b>  | <b>Application and Implementation</b> ..... | <b>14</b> |
| <b>2</b> | <b>应用范围</b> .....                            | <b>1</b>  | 8.1       | Application Information .....               | 14        |
| <b>3</b> | <b>说明</b> .....                              | <b>1</b>  | 8.2       | Typical Application .....                   | 14        |
| <b>4</b> | <b>修订历史记录</b> .....                          | <b>2</b>  | <b>9</b>  | <b>Power Supply Recommendations</b> .....   | <b>18</b> |
| <b>5</b> | <b>Pin Configuration and Functions</b> ..... | <b>3</b>  | <b>10</b> | <b>Layout</b> .....                         | <b>18</b> |
| <b>6</b> | <b>Specifications</b> .....                  | <b>4</b>  | 10.1      | Layout Guidelines .....                     | 18        |
| 6.1      | Absolute Maximum Ratings .....               | 4         | 10.2      | Layout Example .....                        | 19        |
| 6.2      | ESD Ratings .....                            | 4         | 10.3      | Thermal Considerations .....                | 21        |
| 6.3      | Recommended Operating Conditions .....       | 4         | <b>11</b> | <b>器件和文档支持</b> .....                        | <b>22</b> |
| 6.4      | Thermal Information .....                    | 5         | 11.1      | 器件支持 .....                                  | 22        |
| 6.5      | Electrical Characteristics .....             | 5         | 11.2      | 文档支持 .....                                  | 22        |
| 6.6      | Typical Characteristics .....                | 7         | 11.3      | 接收文档更新通知 .....                              | 22        |
| <b>7</b> | <b>Detailed Description</b> .....            | <b>10</b> | 11.4      | 社区资源 .....                                  | 22        |
| 7.1      | Overview .....                               | 10        | 11.5      | 商标 .....                                    | 22        |
| 7.2      | Functional Block Diagram .....               | 11        | 11.6      | 静电放电警告 .....                                | 22        |
| 7.3      | Feature Description .....                    | 12        | 11.7      | Glossary .....                              | 22        |
| 7.4      | Device Functional Modes .....                | 13        | <b>12</b> | <b>机械、封装和可订购信息</b> .....                    | <b>22</b> |

## 4 修订历史记录

注：之前版本的页码可能与当前版本有所不同。

| <b>Changes from Revision C (April 2013) to Revision D</b>   | <b>Page</b> |
|---|-------------|
| • 已添加 器件信息表，规范部分，ESD 额定值表，详细 说明部分，应用和实施部分，电源相关建议部分，布局部分，器件和文档支持部分以及机械、封装和可订购信息部分 .....  | 1           |
| • 已删除 订购信息表；请参见数据表末尾的 POA .....   | 1           |
| • Deleted Operating ambient temperature from <i>Absolute Maximum Ratings</i> table .....                                      | 4           |
| • Deleted Operating ambient temperature from <i>Recommended Operating Conditions</i> table .....                              | 4           |
| • Changed Operating junction temperature maximum value from 150 to 125 in <i>Recommended Operating Conditions</i> table ..... | 4           |

| <b>Changes from Revision B (December 2011) to Revision C</b> | <b>Page</b> |
|--|-------------|
| • 已添加“RSA-16 引脚封装”至 订购信息表 .....                              | 1           |
| • 已更改 说明部分的 文本，以包含 RSA 封装 .....                              | 1           |
| • Added the RSA-16 Pin package pin out .....                 | 3           |
| • Added <a href="#">Figure 26</a> .....                      | 20          |

| <b>Changes from Revision A (October 2011) to Revision B</b>  | <b>Page</b> |
|--|-------------|
| • Deleted MIN and MAX values from $V_{VREG5}$ specification .....  | 5           |
| • Deleted Line and Load regulation specs from $V_{VREG5}$ specification .....  | 5           |
| • Added "Ensured by design. Not production tested" annotation to specifications for MOSFETs, ON-TIME TIMER CONTROL, and SOFT START ..... | 5           |
| • Deleted MIN and MAX values from $V_{UVREG5}$ specification .....   | 5           |
| • Added "VIN = 12 V, T <sub>A</sub> = 25°C (unless otherwise noted)" to Typical Characteristics conditions statement .....               | 7           |

**Changes from Original (October 2011) to Revision A****Page**

- 
- Added indication for not production tested parameters ..... 5
  - Added Over/Under Voltage Protection Description ..... 13
-

## 5 Pin Configuration and Functions

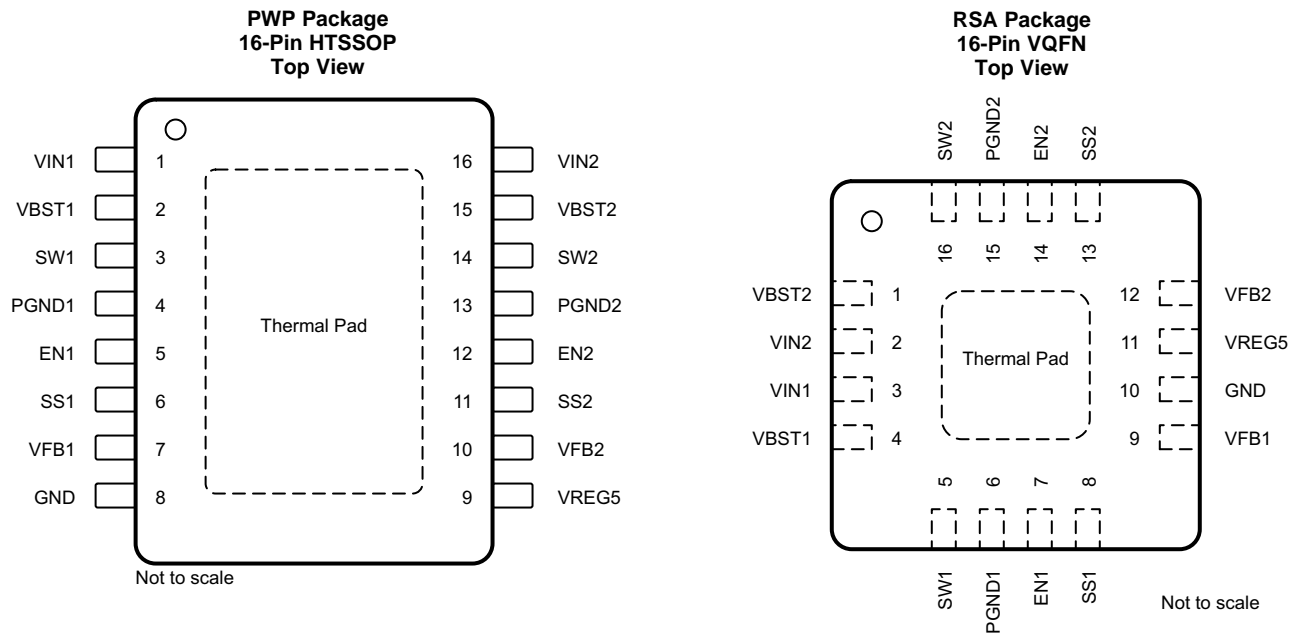

### Pin Functions

| PIN         |        |      | I/O | DESCRIPTION  |
|-------------|--------|------|-----|--|
| NAME        | HTSSOP | VQFN |     |  |
| EN1         | 5      | 7    | I   | Enable. Pull high to enable the corresponding (1 or 2) converter.  |
| EN2         | 12     | 14   |     |  |
| GND         | 8      | 10   | I/O | Signal GND. Connect sensitive SSx and VFBx returns to GND at a single point.   |
| PGND1       | 4      | 6    | I/O | Ground returns for low-side MOSFETs. Input of current comparator.  |
| PGND2       | 13     | 15   |     |  |
| SS1         | 6      | 8    | O   | Soft-start programming pin. Connect capacitor from SSx pin to GND to program soft-start time.  |
| SS2         | 11     | 13   |     |  |
| SW1         | 3      | 5    | I/O | Switch node connections for both the high-side NFETs and low-side NFETs. Input of current comparator.  |
| SW2         | 14     | 16   |     |  |
| VBST1       | 2      | 14   | I   | Supply input for high-side NFET gate drive circuit. Connect a 0.1- $\mu$ F ceramic capacitor between VBSTx and SWx pins. An internal diode is connected between VREG5 and VBSTx. |
| VBST2       | 15     | 1    |     |  |
| VFB1        | 7      | 9    | I   | D-CAP2 feedback inputs. Connect to output voltage with resistor divider.   |
| VFB2        | 10     | 12   |     |  |
| VIN1        | 1      | 3    | I   | Power inputs and connects to both high-side NFET drains. Supply Input for 5.5-V linear regulator.  |
| VIN2        | 16     | 2    |     |  |
| VREG5       | 9      | 11   | O   | Output of 5.5-V linear regulator. Bypass to GND with a high-quality ceramic capacitor of at least 1 $\mu$ F. VREG5 is active when VIN1 is added.                                 |
| Thermal Pad | —      | —    | —   | Thermal pad of the package. Must be soldered to ground to achieve appropriate dissipation. Must be connected to GND.   |

## 6 Specifications

### 6.1 Absolute Maximum Ratings

over operating free-air temperature range (unless otherwise noted)<sup>(1)(2)</sup>

|                                       |                                | MIN  | MAX | UNIT |
|---------------------------------------|--------------------------------|------|-----|------|
| Input voltage                         | VIN1, VIN2, EN1, EN2           | -0.3 | 20  | V    |
|                                       | VBST1, VBST2                   | -0.3 | 26  |      |
|                                       | VBST1, VBST2 (10-ns transient) | -0.3 | 28  |      |
|                                       | VBST1 – SW1, VBST2 – SW2       | -0.3 | 6.5 |      |
|                                       | VFB1, VFB2                     | -0.3 | 6.5 |      |
|                                       | SW1, SW2                       | -2   | 20  |      |
|                                       | SW1, SW2 (10-ns transient)     | -3   | 22  |      |
| Output voltage                        | VREG5, SS1, SS2                | -0.3 | 6.5 | V    |
|                                       | PGND1, PGND2                   | -0.3 | 0.3 |      |
| Junction temperature, T <sub>J</sub>  |                                | -40  | 150 | °C   |
| Storage temperature, T <sub>stg</sub> |                                | -55  | 150 | °C   |

- (1) Stresses beyond those listed under *Absolute Maximum Ratings* may cause permanent damage to the device. These are stress ratings only, which do not imply functional operation of the device at these or any other conditions beyond those indicated under *Recommended Operating Conditions*. Exposure to absolute-maximum-rated conditions for extended periods may affect device reliability.
- (2) All voltages are with respect to IC GND terminal.

### 6.2 ESD Ratings

|                    |                         | VALUE  | UNIT  |
|--------------------|-------------------------|--|-------|
| V <sub>(ESD)</sub> | Electrostatic discharge | Human-body model (HBM), per ANSI/ESDA/JEDEC JS-001 <sup>(1)</sup>              | ±2000 |
|                    |                         | Charged-device model (CDM), per JEDEC specification JESD22-C101 <sup>(2)</sup> | ±500  |

- (1) JEDEC document JEP155 states that 500-V HBM allows safe manufacturing with a standard ESD control process.
- (2) JEDEC document JEP157 states that 250-V CDM allows safe manufacturing with a standard ESD control process.

### 6.3 Recommended Operating Conditions

over operating free-air temperature range (unless otherwise noted)

|                      |                                | MIN  | MAX | UNIT |
|----------------------|--------------------------------|------|-----|------|
| Supply input voltage | VIN1, VIN2                     | 4.5  | 18  | V    |
| Input voltage        | VBST1, VBST2                   | -0.1 | 24  | V    |
|                      | VBST1, VBST2 (10-ns transient) | -0.1 | 27  |      |
|                      | VBST1 – SW1, VBST2 – SW2       | -0.1 | 5.7 |      |
|                      | VFB1, VFB2                     | -0.1 | 5.7 |      |
|                      | EN1, EN2                       | -0.1 | 18  |      |
|                      | SW1, SW2                       | -1   | 18  |      |
|                      | SW1, SW2 (10-ns transient)     | -3   | 21  |      |
| Output voltage       | VREG5, SS1, SS2                | -0.1 | 5.7 | V    |
|                      | PGND1, PGND2                   | -0.1 | 0.1 |      |
|                      | VO1, VO2                       | 0.76 | 7   |      |
| T <sub>J</sub>       | Operating Junction Temperature | -40  | 125 | °C   |

## 6.4 Thermal Information

| THERMAL METRIC <sup>(1)</sup>                                      | TPS54295     |            | UNIT |
|--|--------------|------------|------|
|  | PWP (HTSSOP) | RSA (VQFN) |      |
|  | 16 PINS      | 16 PINS    |      |
| R <sub>θJA</sub> Junction-to-ambient thermal resistance            | 47.5         | 34.9       | °C/W |
| R <sub>θJC(top)</sub> Junction-to-case (top) thermal resistance    | 27.1         | 40         | °C/W |
| R <sub>θJB</sub> Junction-to-board thermal resistance              | 20.8         | 11.8       | °C/W |
| ψ <sub>JT</sub> Junction-to-top characterization parameter         | 1            | 0.7        | °C/W |
| ψ <sub>JB</sub> Junction-to-board characterization parameter       | 20.6         | 11.3       | °C/W |
| R <sub>θJC(bot)</sub> Junction-to-case (bottom) thermal resistance | 2.7          | 3.3        | °C/W |

(1) For more information about traditional and new thermal metrics, see the [Semiconductor and IC Package Thermal Metrics](#) application report.

## 6.5 Electrical Characteristics

over recommended free-air temperature range, V<sub>IN</sub> = 12 V (unless otherwise noted)

| PARAMETER   | TEST CONDITIONS   | MIN   | TYP  | MAX  | UNIT   |
|---|---|-------|------|------|--------|
| <b>SUPPLY CURRENT</b>                                       |   |       |      |      |        |
| I <sub>IN</sub> VINx supply current                         | T <sub>A</sub> = 25°C, V <sub>EN1</sub> = V <sub>EN2</sub> = 5 V, V <sub>VFB1</sub> = V <sub>VFB2</sub> = 0.8 V |       | 1300 | 2000 | μA     |
| I <sub>VINSDN</sub> VINx shutdown current                   | T <sub>A</sub> = 25°C, V <sub>EN1</sub> = V <sub>EN2</sub> = 0 V  |       | 80   | 150  | μA     |
| <b>FEEDBACK VOLTAGE</b>                                     |   |       |      |      |        |
| V <sub>VFBTHLX</sub> VFBx threshold voltage                 | T <sub>A</sub> = 25°C, V <sub>CH1</sub> = 3.3 V, V <sub>CH2</sub> = 1.5 V                                       | 758   | 765  | 773  | mV     |
| TC <sub>VFBX</sub> Temperature coefficient                  | On the basis of 25°C <sup>(1)</sup>   | -115  |      | 115  | ppm/°C |
| I <sub>VFBX</sub> VFBx Input Current                        | V <sub>VFBX</sub> = 0.8 V, T <sub>A</sub> = 25°C  | -0.35 | 0.2  | 0.35 | μA     |
| <b>VREG5 OUTPUT</b>   |   |       |      |      |        |
| V <sub>VREG5</sub> VREG5 output voltage                     | T <sub>A</sub> = 25°C, 6 V < V <sub>IN1</sub> < 18 V, I <sub>VREG5</sub> = 5 mA                                 |       | 5.5  |      | V      |
| I <sub>VREG5</sub> Output current                           | V <sub>IN1</sub> = 6 V, V <sub>VREG5</sub> = 4 V, T <sub>A</sub> = 25°C <sup>(1)</sup>                          |       | 75   |      | mA     |
| <b>MOSFETs</b>  |   |       |      |      |        |
| r <sub>DS(ON)H</sub> High-side switch resistance            | T <sub>A</sub> = 25°C, V <sub>VBSTx</sub> - V <sub>SWx</sub> = 5.5 V <sup>(1)</sup>                             |       | 150  |      | mΩ     |
| r <sub>DS(ON)L</sub> Low-side switch resistance             | T <sub>A</sub> = 25°C <sup>(1)</sup>  |       | 100  |      | mΩ     |
| <b>ON-TIME TIMER CONTROL</b>                                |   |       |      |      |        |
| T <sub>ON1</sub> SW1 ON time                                | V <sub>SW1</sub> = 12 V, V <sub>OUT1</sub> = 1.2 V  |       | 165  |      | ns     |
| T <sub>ON2</sub> SW2 ON time                                | V <sub>SW2</sub> = 12 V, V <sub>OUT2</sub> = 1.2 V  |       | 165  |      | ns     |
| T <sub>OFF1</sub> SW1 minimum OFF time                      | T <sub>A</sub> = 25°C, V <sub>VFB1</sub> = 0.7 V <sup>(1)</sup>   |       | 220  |      | ns     |
| T <sub>OFF2</sub> SW2 minimum OFF time                      | T <sub>A</sub> = 25°C, V <sub>VFB2</sub> = 0.7 V <sup>(1)</sup>   |       | 220  |      | ns     |
| <b>SOFT START</b>   |   |       |      |      |        |
| I <sub>SSC</sub> SSx charge current                         | V <sub>SSx</sub> = 0.5 V, T <sub>A</sub> = 25°C   | -8.4  | -8   | -7.6 | μA     |
| TC <sub>ISSC</sub> I <sub>SSC</sub> temperature coefficient | On the basis of 25°C <sup>(1)</sup> (PWP)   | -4    |      | 3    | nA/°C  |
|   | On the basis of 25°C <sup>(1)</sup> (RSA)   | -4    |      | 5    |        |
| I <sub>SSD</sub> SSx discharge current                      | V <sub>SSx</sub> = 0.5 V  | 3     | 7    | 10   | mA     |
| <b>UVLO</b>   |   |       |      |      |        |
| V <sub>UVREG5</sub> VREG5 UVLO threshold                    | VREG5 rising  |       | 3.83 |      | V      |
|   | Hysteresis  |       | 0.6  |      |        |
| <b>LOGIC THRESHOLDS</b>                                     |   |       |      |      |        |
| V <sub>ENxH</sub> ENx H-level threshold voltage             |   | 2     |      |      | V      |
| V <sub>ENxL</sub> ENx L-level threshold voltage             |   |       |      | 0.4  | V      |
| R <sub>ENx_IN</sub> ENx input resistance                    | V <sub>ENx</sub> = 12 V   | 225   | 450  | 900  | kΩ     |
| <b>CURRENT LIMITS</b>                                       |   |       |      |      |        |
| I <sub>OCL</sub> Current limit                              | L <sub>OUT</sub> = 2.2 μH <sup>(1)</sup>  | 2.7   | 3.9  | 4.5  | A      |

(1) Ensured by design. Not production tested.

**Electrical Characteristics (continued)**

 over recommended free-air temperature range,  $V_{IN} = 12\text{ V}$  (unless otherwise noted)

| PARAMETER  |                            | TEST CONDITIONS                      | MIN          | TYP          | MAX        | UNIT          |
|--|----------------------------|--------------------------------------|--------------|--------------|------------|---------------|
| <b>OUTPUT UNDERVOLTAGE AND OVERVOLTAGE PROTECTION (UVP, OVP)</b> |                            |                                      |              |              |            |               |
| $V_{OVP}$  | Output OVP trip threshold  | measured on VFBx                     | 115%         | 120%         | 125%       |               |
| $T_{OVPDEL}$   | Output OVP prop delay      |                                      |              | 3            | 10         | $\mu\text{s}$ |
| $V_{UVP}$  | Output UVP trip threshold  | measured on VFBx                     | 63%          | 68%          | 73%        |               |
| $T_{UVPDEL}$   | Output UVP delay time      |                                      |              | 1.5          |            | ms            |
| $T_{UVPEN}$  | Output UVP enable delay    | UVP enable delay and soft-start time | $\times 1.4$ | $\times 1.7$ | $\times 2$ |               |
| <b>THERMAL SHUTDOWN</b>  |                            |                                      |              |              |            |               |
| $T_{SD}$   | Thermal shutdown threshold | Shutdown temperature <sup>(1)</sup>  |              | 155          |            | °C            |
|  |                            | Hysteresis <sup>(1)</sup>            |              | 25           |            |               |

## 6.6 Typical Characteristics

One output is enabled unless otherwise noted.  $V_I = V_{IN1}$  or  $V_{IN2}$ .  $V_{IN} = 12\text{ V}$ ,  $T_A = 25^\circ\text{C}$  (unless otherwise noted).

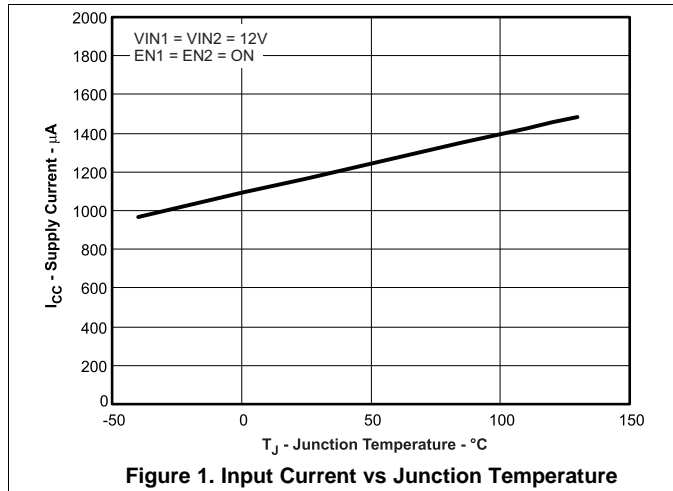

Figure 1. Input Current vs Junction Temperature

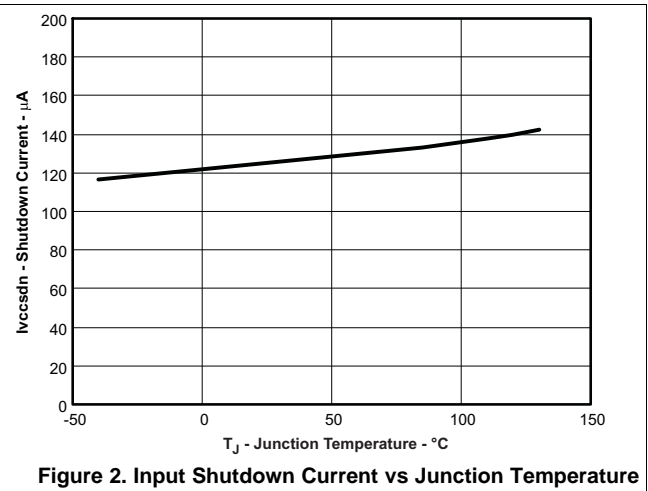

Figure 2. Input Shutdown Current vs Junction Temperature

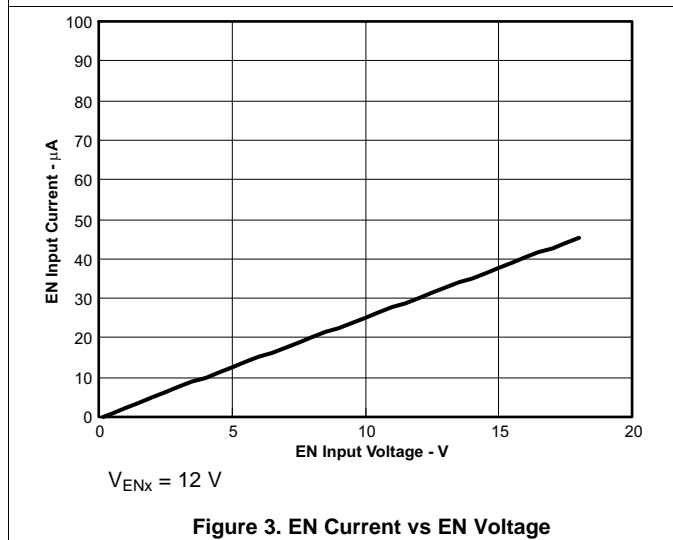

Figure 3. EN Current vs EN Voltage

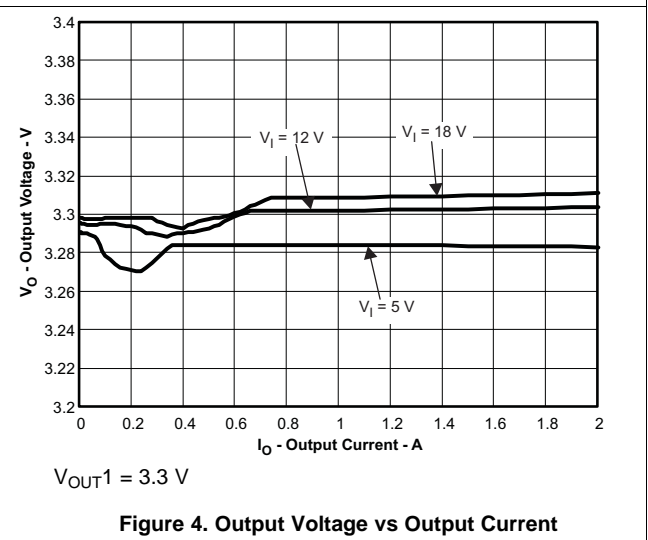

Figure 4. Output Voltage vs Output Current

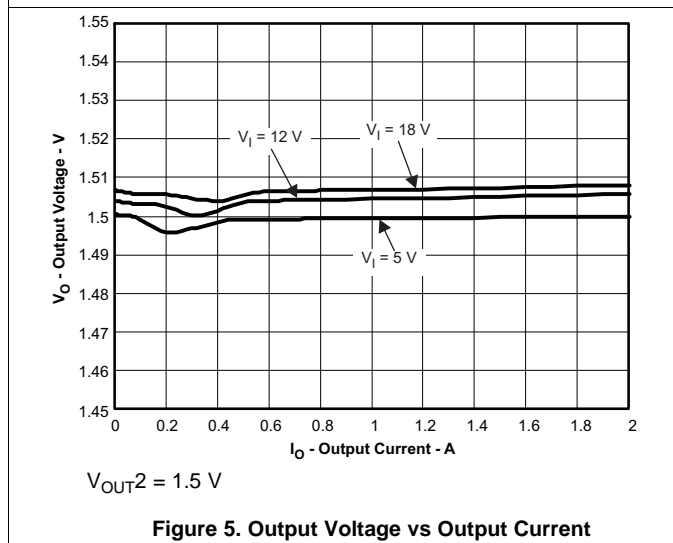

Figure 5. Output Voltage vs Output Current

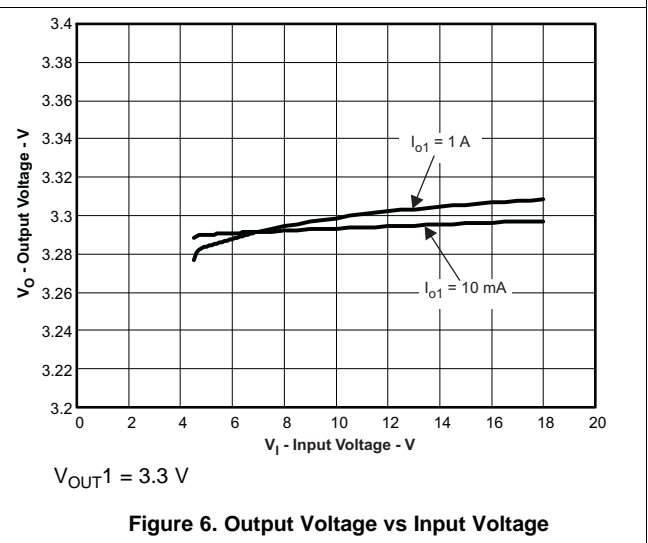
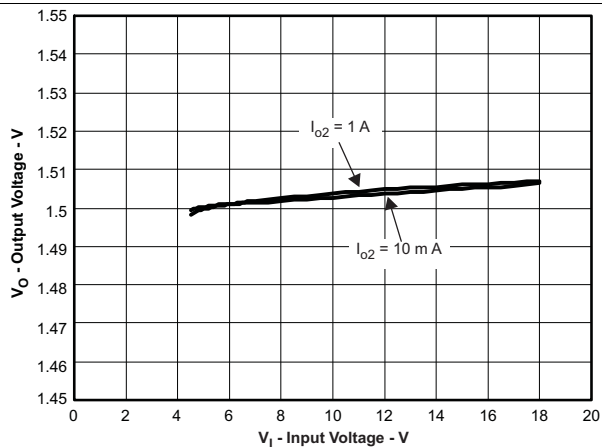

Figure 6. Output Voltage vs Input Voltage



Typical Characteristics (continued)

One output is enabled unless otherwise noted.  $V_I = V_{IN1}$  or  $V_{IN2}$ .  $V_{IN} = 12\text{ V}$ ,  $T_A = 25^\circ\text{C}$  (unless otherwise noted).



$V_{OUT2} = 1.5\text{ V}$

Figure 7. Output Voltage vs Input Voltage

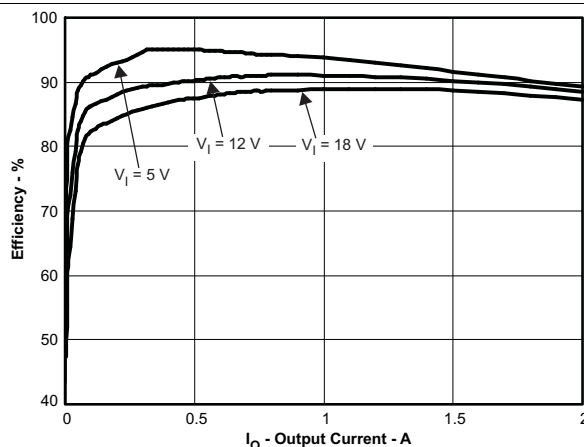

$V_{OUT1} = 3.3\text{ V}$

Figure 8. Efficiency vs Output Current

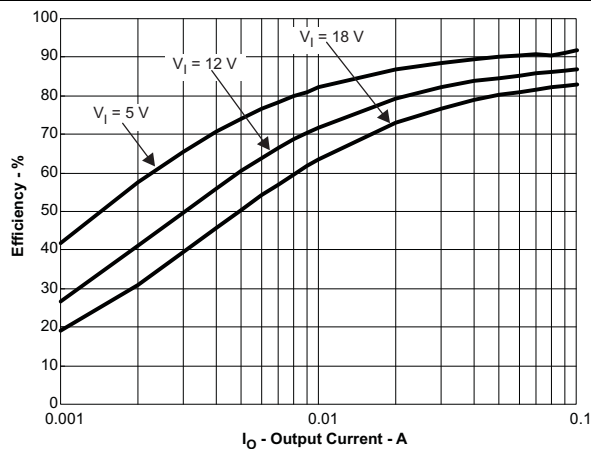

$V_{OUT1} = 3.3\text{ V}$

Figure 9. Efficiency vs Output Current

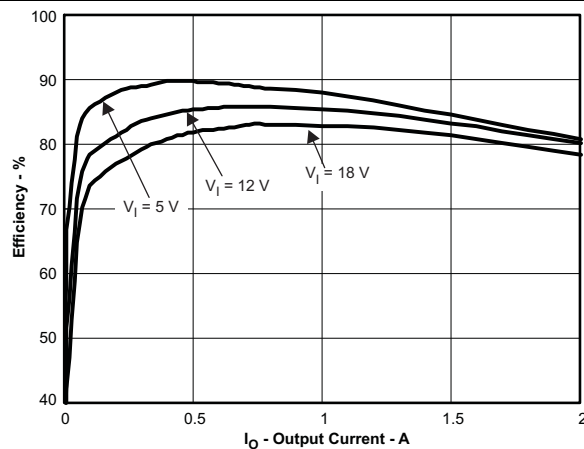

$V_{OUT1} = 1.5\text{ V}$

Figure 10. Efficiency vs Output Current

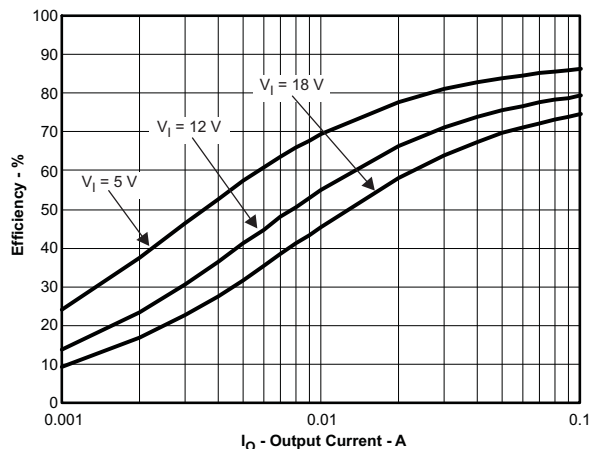

$V_{OUT2} = 1.5\text{ V}$

Figure 11. Efficiency vs Output Current

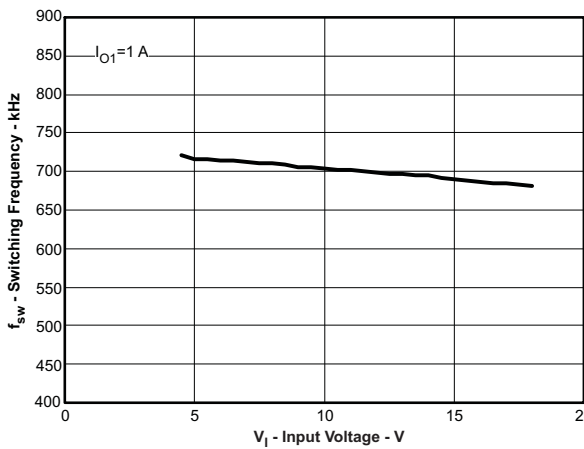

$V_{OUT1} = 3.3\text{ V}$

Figure 12. Switching Frequency vs Input Voltage

### Typical Characteristics (continued)

One output is enabled unless otherwise noted.  $V_I = V_{IN1}$  or  $V_{IN2}$ .  $V_{IN} = 12\text{ V}$ ,  $T_A = 25^\circ\text{C}$  (unless otherwise noted).

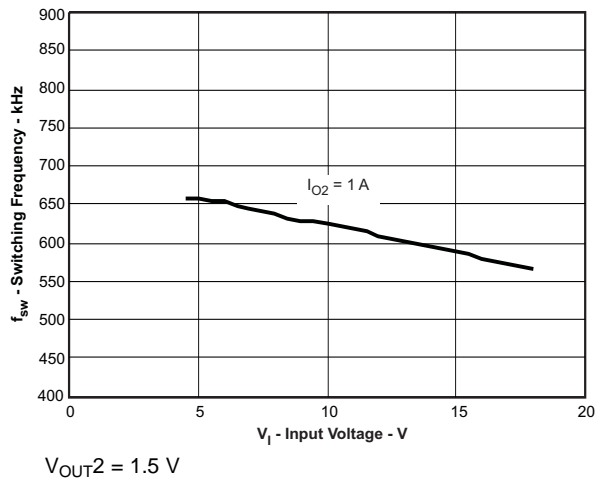

Figure 13. Switching Frequency vs Input Voltage

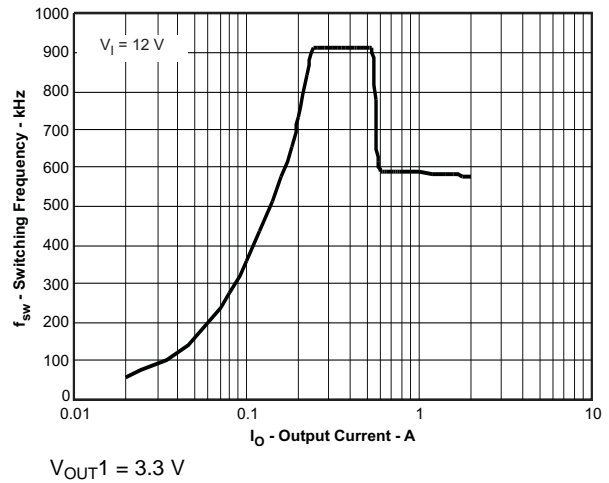

Figure 14. Switching Frequency vs Output Current

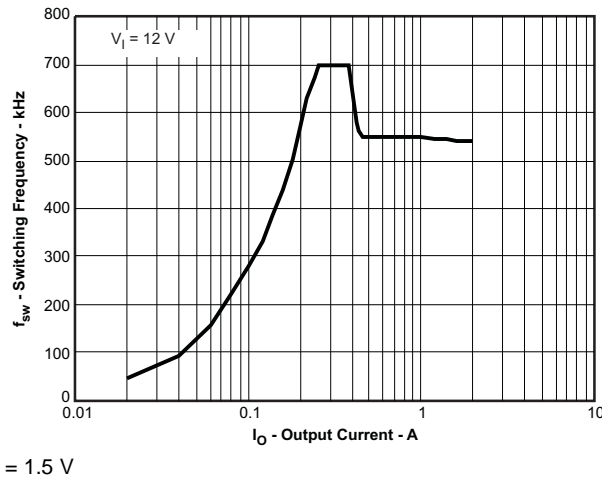

Figure 15. Switching Frequency vs Output Current

## 7 Detailed Description

### 7.1 Overview

The TPS54295 is a 2-A and 2-A, dual synchronous step-down (buck) converter with two integrated N-channel MOSFETs for each channel. It operates using D-CAP2 control mode. The fast transient response of D-CAP2 control reduces the required output capacitance to meet a specific level of performance. Proprietary internal circuitry allows the use of low ESR output capacitors including ceramic and special polymer types.



## 7.3 Feature Description

### 7.3.1 PWM Operation

The main control loop of the TPS54295 is an adaptive on-time pulse width modulation (PWM) controller that supports a proprietary D-CAP2 control mode. D-CAP2 control combines constant on-time control with an internal compensation circuit for pseudo-fixed frequency and low external component count configuration with both low ESR and ceramic output capacitors. It is stable even with virtually no ripple at the output.

At the beginning of each cycle, the high-side MOSFET is turned on. This MOSFET is turned off when the internal timer expires. This timer is set by the converter's input voltage ( $V_{INX}$ ) and the output voltage ( $V_{OUTX}$ ) to maintain a pseudo-fixed frequency over the input voltage range hence it is called adaptive on-time control. The timer is reset and the high-side MOSFET is turned on again when the feedback voltage falls below the nominal output voltage. An internal ramp is added to the reference voltage to simulate output voltage ripple, eliminating the need for ESR induced output ripple from D-CAP control.

### 7.3.2 PWM Frequency and Adaptive On-Time Control

TPS54295 uses an adaptive on-time control scheme and does not have a dedicated on board oscillator. The TPS54295 runs with a pseudo-fixed frequency of 700 kHz by using the input voltage and output voltage to set the on-time timer. The on-time is inversely proportional to the input voltage and proportional to the output voltage, therefore, when the duty ratio is  $V_{OUTX} / V_{INX}$ , the frequency is constant.

### 7.3.3 Auto-Skip Eco-Mode Control

The TPS54295 is designed with auto-skip Eco-mode to increase light load efficiency. As the output current decreases from heavy load condition, the inductor current also reduces and eventually comes to the point where its ripple valley touches the zero level, which is the boundary between continuous conduction and discontinuous conduction modes. The rectifying MOSFET is turned off when zero inductor current is detected. As the load current further decreases the converter runs into discontinuous conduction mode. The on-time is kept almost half as it was in the continuous conduction mode because it takes longer to discharge the output capacitor with smaller load current to the nominal output voltage. The transition point to the light load operation current ( $I_{OUT(LL)X}$ ) can be estimated with Equation 1 with 700 kHz used as  $f_{SW}$ .

$$I_{OUT(LL)X} = \frac{1}{2 \times L1X \times f_{SW}} \times \frac{(V_{INX} - V_{OUTX}) \times V_{OUTX}}{V_{INX}} \quad (1)$$

### 7.3.4 Soft Start and Prebiased Soft Start

The soft-start time is adjustable. When the ENx pin becomes high, 8- $\mu$ A current begins charging the capacitor which is connected from the SSx pin to GND. Smooth control of the output voltage is maintained during start-up. Calculate the slow-start time with Equation 2. VFBx voltage is 0.765 V and SSx pin source current is 8  $\mu$ A.

$$T_{SS}(\text{ms}) = \frac{C4X(\text{nF}) \times VFBX(\text{V})}{I_{SS}(\mu\text{A})} = \frac{C4X(\text{nF}) \times 0.765 \text{ V}}{8 \mu\text{A}} \quad (2)$$

The TPS54295 contains a unique circuit to prevent current from being pulled from the output during start-up if the output is prebiased. When the soft start commands a voltage higher than the prebias level (internal soft start becomes greater than internal feedback voltage), the controller slowly activates synchronous rectification by starting the first low side FET gate driver pulses with a narrow on-time. It then increments that on-time on a cycle-by-cycle basis until it coincides with the time dictated by  $1 - D$ , where D is the duty cycle of the converter. This scheme prevents the initial sinking of the prebiased output, and ensures that the output voltage starts and ramps up smoothly into regulation from prebiased start-up to normal mode operation.

### 7.3.5 Overcurrent Protection

The output overcurrent protection (OCP) is implemented using a cycle-by-cycle valley detection control circuit. The switch current is monitored by measuring the low-side FET switch voltage between the SWx and PGNDx pins. This voltage is proportional to the switch current and the on-resistance of the FET. To improve the measurement accuracy, the voltage sensing is temperature compensated.

## Feature Description (continued)

During the ON time of the high-side FET switch, the switch current increases at a linear rate determined by  $V_{INX}$ ,  $V_{OUTX}$ , the ON time, and the output inductor value. During the ON time of the low-side FET switch, this current decreases linearly. The average value of the switch current is the load current ( $I_{OUTX}$ ). If the sensed voltage on the low-side FET is above the voltage proportional to the current limit, the converter keeps the low-side switch on until the measured voltage falls below the voltage corresponding to the current limit and a new switching cycle begins. In subsequent switching cycles, the on-time is set to the value determined for CCM and the current is monitored in the same manner.

Following are some important considerations for this type of overcurrent protection. The load current is one half of the peak-to-peak inductor current higher than the overcurrent threshold. Also when the current is being limited, the output voltage tends to fall as the demanded load current may be higher than the current available from the converter. When the overcurrent condition is removed, the output voltage returns to the regulated value. This protection is non-latching.

### 7.3.6 Overvoltage and Undervoltage Protection

TPS54295 monitors the resistor divided feedback voltage to detect overvoltage and undervoltage. If the feedback voltage is higher than 120% of the reference voltage, the OVP comparator output goes high and the circuit latches both the high-side MOSFET driver and the low-side MOSFET driver off. When the feedback voltage is lower than 68% of the reference voltage, the UVP comparator output goes high and an internal UVP delay counter begins counting. After 1.5 ms, TPS54295 latches OFF both the high-side MOSFET and the low-side MOSFET drivers. This function is enabled approximately 1.7 times the soft-start time after power on. The OVP and UVP latch off is reset when EN is toggled.

### 7.3.7 UVLO Protection

Undervoltage lockout protection (UVLO) monitors the voltage of the VREG5 pin. When the VREG5 voltage is lower than the UVLO threshold, the TPS54295 shuts down. As soon as the voltage increases above the UVLO threshold, the converter starts again.

### 7.3.8 Thermal Shutdown

TPS54295 monitors its temperature. If the temperature exceeds the threshold value (typically 155°C), the device shuts down. When the temperature falls below the threshold, the IC starts again.

When VIN1 starts up and VREG5 output voltage is below its nominal value, the thermal shutdown threshold is lower than 155°C. As long as VIN1 rises,  $T_J$  must be kept below 110°C.

## 7.4 Device Functional Modes

### 7.4.1 Normal Operation

When the input voltage is above the UVLO threshold and the EN voltage is above the enable threshold, the TPS54295 can operate in the normal switching modes. Normal continuous conduction mode (CCM) occurs when the minimum switch current is above 0 A. In CCM, the TPS54295 operates at a quasi-fixed frequency of 700 kHz while  $V_{OUT1} = V_{OUT2} = 3.3$  V.

### 7.4.2 Eco-Mode Operation

When the TPS54295 is in the normal CCM operating mode and the switch current falls to 0 A, the TPS54295 begins operating in pulse skipping Eco-mode. Each switching cycle is followed by a period of energy saving sleep time. The sleep time ends when the VFB voltage falls below the Eco-mode threshold voltage. As the output current decreases, the perceived time between switching pulses increases.

### 7.4.3 Standby Operation

When the TPS54295 is operating in either normal CCM or Eco-mode, it may be placed in standby mode by asserting the EN pin low.

## 8 Application and Implementation

### NOTE

Information in the following applications sections is not part of the TI component specification, and TI does not warrant its accuracy or completeness. TI's customers are responsible for determining suitability of components for their purposes. Customers should validate and test their design implementation to confirm system functionality.

### 8.1 Application Information

The TPS54295 is a typical step-down DC-DC converter. The device typically is used to convert a higher DC voltage to a lower DC voltage with a maximum output current of 2 A.

### 8.2 Typical Application

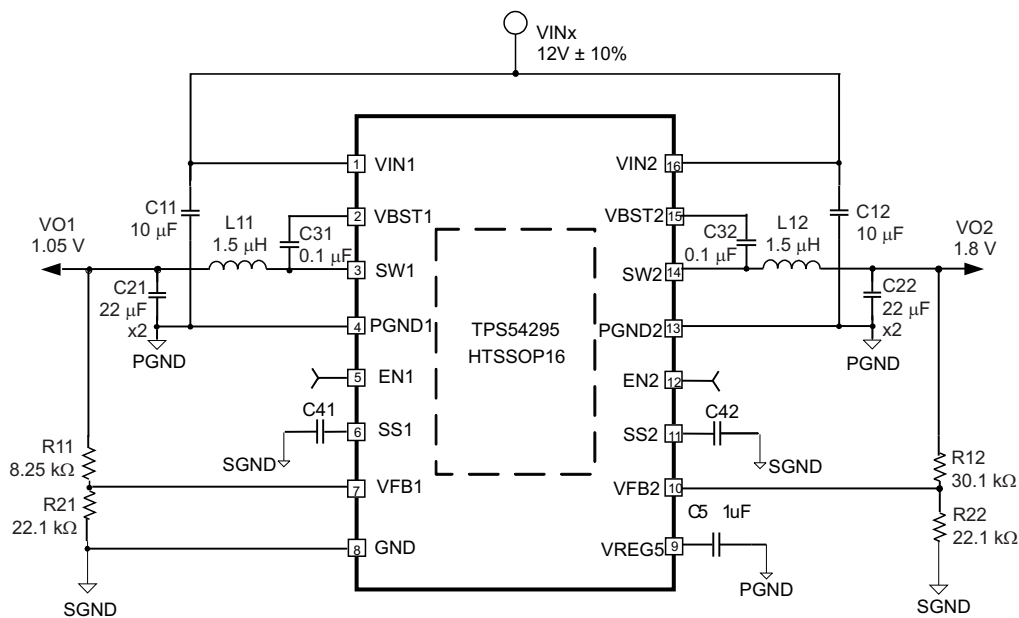

Copyright © 2016, Texas Instruments Incorporated

Figure 16. Schematic Diagram for the Design Example

#### 8.2.1 Design Requirements

For this design example, use the parameters listed in Table 1 as the input parameters.

Table 1. Design Parameters

| PARAMETER                            | EXAMPLE VALUE              |
|--------------------------------------|----------------------------|
| Input voltage                        | 4.5 V to 18 V              |
| Output voltage                       | 1.05 V and 1.8 V           |
| Transient response (1.5-A load step) | $\Delta V_{OUT} = \pm 5\%$ |
| Input ripple voltage                 | 400 mV                     |
| Output ripple voltage                | 30 mV                      |
| Output current rating                | 2 A                        |
| Operating frequency                  | 700 kHz                    |

## 8.2.2 Detailed Design Procedure

This section presents a simplified design process and guidelines for component selection. Alternatively the WEBENCH<sup>®</sup> software may be used to generate a complete design. WEBENCH uses an iterative design procedure and accesses a comprehensive database of components when generating a design.

To begin the design process, determine the following application parameters:

- Input voltage
- Output voltage
- Output current

In all formulas  $x$  is used to indicate that they are valid for both converters. For the calculations the estimated switching frequency of 700 kHz is used.

### 8.2.2.1 Output Voltage Resistors Selection

The output voltage is set with a resistor divider from the output node to the VFB $x$  pin. TI recommends 1% tolerance or better divider resistors. Start by using Equation 3 to calculate  $V_{OUTx}$ .

To improve the efficiency at very light loads consider using larger value resistors, but resistance values that are too high make the device susceptible to noise and voltage errors due to the VFB $x$  input current being more noticeable.

$$V_{OUTx} = 0.765 \text{ V} \times \left( 1 + \frac{R1x}{R2x} \right) \quad (3)$$

### 8.2.2.2 Output Filter Selection

The output filter used with the TPS54295 is an LC circuit. This LC filter has a double pole at:

$$F_p = \frac{1}{2\pi\sqrt{L1x \times C1x}} \quad (4)$$

At low frequencies, the overall loop gain is set by the output set-point resistor divider network and the internal gain of the TPS545295. The low frequency phase is 180 degrees. At the output filter pole frequency, the gain rolls off at a –40 dB per decade rate and the phase drops rapidly. D-CAP2 introduces a high frequency zero that reduces the gain roll off to –20 dB per decade and increases the phase to 90 degrees one decade above the zero frequency. The inductor and capacitor selected for the output filter must be selected so that the double pole of Equation 4 is located below the high frequency zero but close enough that the phase boost provided by the high frequency zero provides adequate phase margin for a stable circuit. To meet this requirement use the values recommended in Table 2.

**Table 2. Recommended Component Values**

| OUTPUT VOLTAGE (V) | R1x (k $\Omega$ ) | R2x (k $\Omega$ ) | C <sub>FFx</sub> (pF) <sup>(1)</sup> | L1x ( $\mu$ H) | C2x ( $\mu$ F) |
|--------------------|-------------------|-------------------|--------------------------------------|----------------|----------------|
| 1                  | 6.81              | 22.1              | —                                    | 1 to 1.5       | 22 to 68       |
| 1.05               | 8.25              | 22.1              | —                                    | 1 to 1.5       | 22 to 68       |
| 1.2                | 12.7              | 22.1              | —                                    | 1 to 1.5       | 22 to 68       |
| 1.5                | 21.5              | 22.1              | —                                    | 1.5            | 22 to 68       |
| 1.8                | 30.1              | 22.1              | 5 to 22                              | 1.5            | 22 to 68       |
| 2.5                | 49.9              | 22.1              | 5 to 22                              | 2.2            | 22 to 68       |
| 3.3                | 73.2              | 22.1              | 5 to 22                              | 2.2            | 22 to 68       |
| 5                  | 124               | 22.1              | 5 to 22                              | 3.3            | 22 to 68       |

(1) Optional

For higher output voltages at or above 1.8 V, additional phase boost can be achieved by adding a feed forward capacitor ( $C_{FF}$ ) in parallel with R1.

The inductor peak-to-peak ripple current, peak current and RMS current are calculated using Equation 5, Equation 6, and Equation 7. The inductor saturation current rating must be greater than the calculated peak current and the RMS or heating current rating must be greater than the calculated RMS current.



For the calculations, use 700 kHz as the switching frequency ( $f_{SW}$ ). Make sure the chosen inductor is rated for the peak current of Equation 6 and the RMS current of Equation 7.

$$\Delta I_{L1x} = \frac{V_{OUTx}}{V_{IN(MAX)x}} \times \frac{V_{IN(MAX)x} - V_{OUTx}}{L1x \times f_{SW}} \quad (5)$$

$$I_{L1xpeak} = I_{OUTx} + \frac{\Delta I_{L1x}}{2} \quad (6)$$

$$I_{L1x(RMS)} = \sqrt{I_{OUTx}^2 + \frac{1}{12} \Delta I_{L1x}^2} \quad (7)$$

For this design example, the calculated peak current is 2.46 A and the calculated RMS current is 2.02 A for  $V_{OUT1}$ . The inductor used has a rated current of 7.3 A based on the inductance change and of 4.9 A based on the temperature rise.

The capacitor value and ESR determines the amount of output voltage ripple. The TPS54295 is intended for use with ceramic or other low ESR capacitors. TI recommends a value from 22  $\mu$ F to 68  $\mu$ F. Use Equation 8 to determine the required RMS current rating for the output capacitors.

$$I_{C2x(RMS)} = \frac{V_{OUTx} \times (V_{INx} - V_{OUTx})}{\sqrt{12} \times V_{INx} \times L1x \times f_{SW}} \quad (8)$$

For this design two 22- $\mu$ F output capacitors are used. The typical ESR is 2 m $\Omega$  each. The calculated RMS current is 0.19 A and each output capacitor is rated for 4 A.

### 8.2.2.3 Input Capacitor Selection

The TPS54295 requires an input decoupling capacitor and a bulk capacitor may be required depending on the application. TI recommends a ceramic capacitor of at least 10  $\mu$ F for the decoupling capacitor. Additionally, TI recommends 0.1- $\mu$ F ceramic capacitors from VIN1 and VIN2 to ground to improve the stability and reduce the SWx node overshoots. The capacitors' voltage rating must be greater than the maximum input voltage.

### 8.2.2.4 Bootstrap Capacitor Selection

A 0.1- $\mu$ F ceramic capacitor must be connected between the VBSTx and SWx pins for proper operation. TI recommends ceramic capacitors with a dielectric of X5R or better.

### 8.2.2.5 VREG5 Capacitor Selection

A 1- $\mu$ F ceramic capacitor must be connected between the VREG5 and GND pins for proper operation. TI recommends a ceramic capacitor with a dielectric of X5R or better.

8.2.3 Application Curves

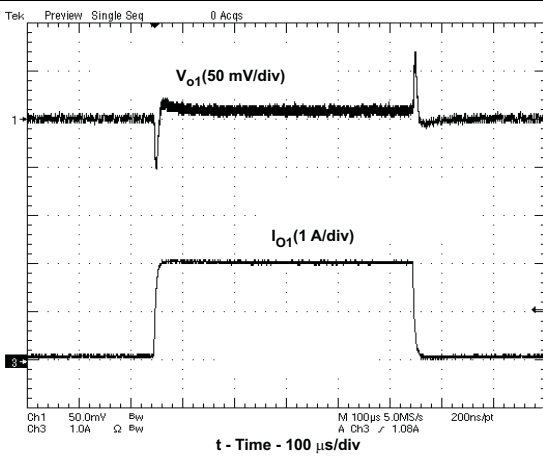

$V_{OUT1} = 3.3\text{ V}$

Figure 17. 0-A to 2-A Load Transient Response

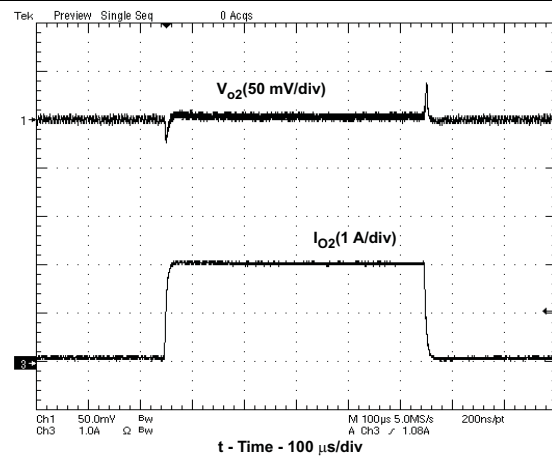

$V_{OUT2} = 1.5\text{ V}$

Figure 18. 0-A to 2-A Load Transient Response

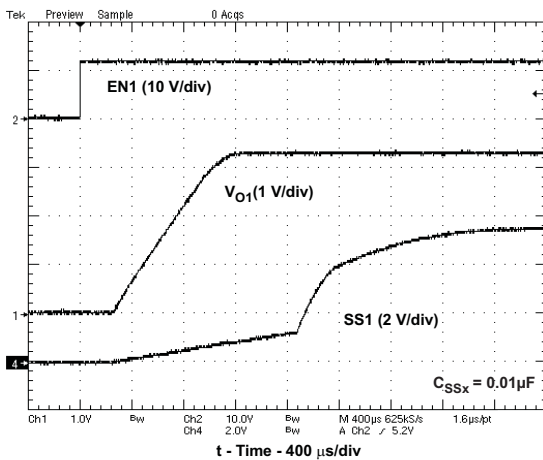

$V_{OUT1} = 3.3\text{ V}$

Figure 19. Soft Start

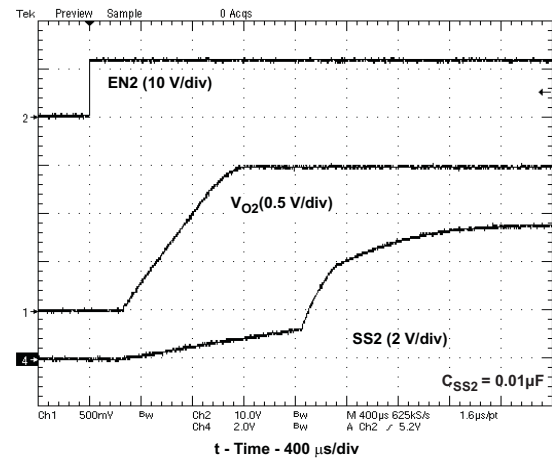

$V_{OUT2} = 1.5\text{ V}$

Figure 20. Soft Start

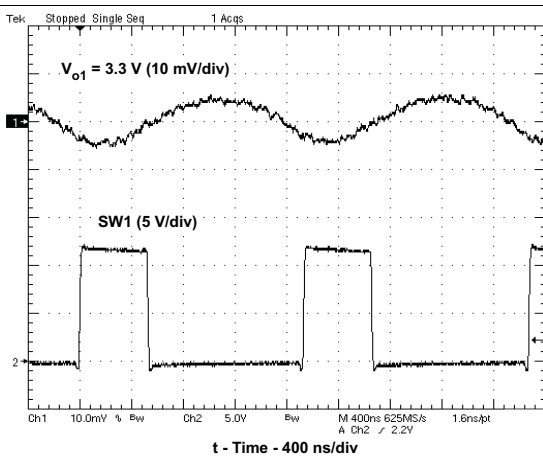

$V_{OUT1} = 3.3\text{ V}$

$I_{OUT1} = 2\text{ A}$

Figure 21.  $V_{OUT1}$  Ripple Voltage

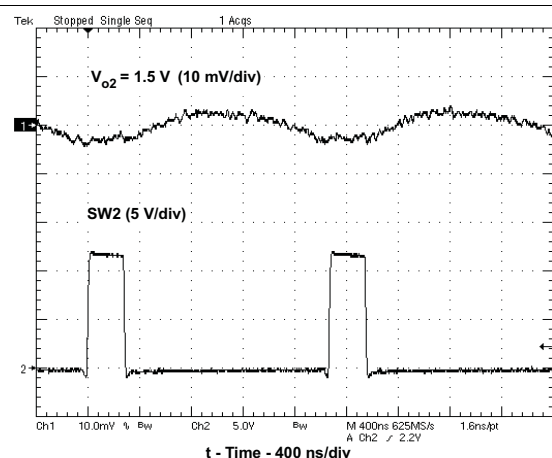

$V_{OUT2} = 1.5\text{ V}$

$I_{OUT2} = 2\text{ A}$

Figure 22.  $V_{OUT2}$  Ripple Voltage

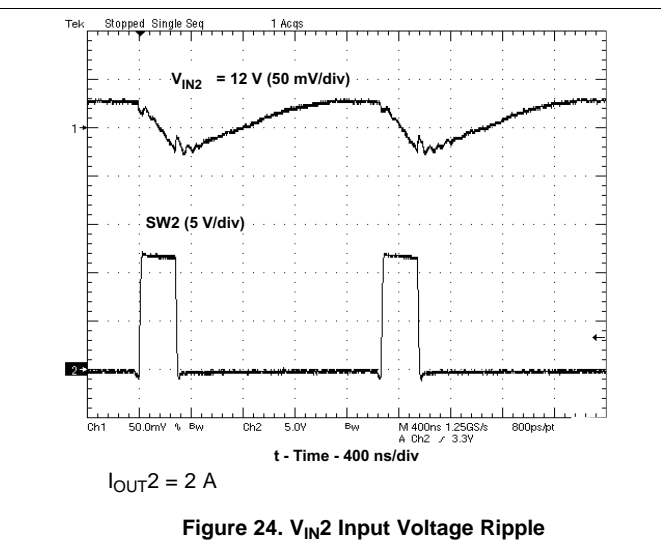
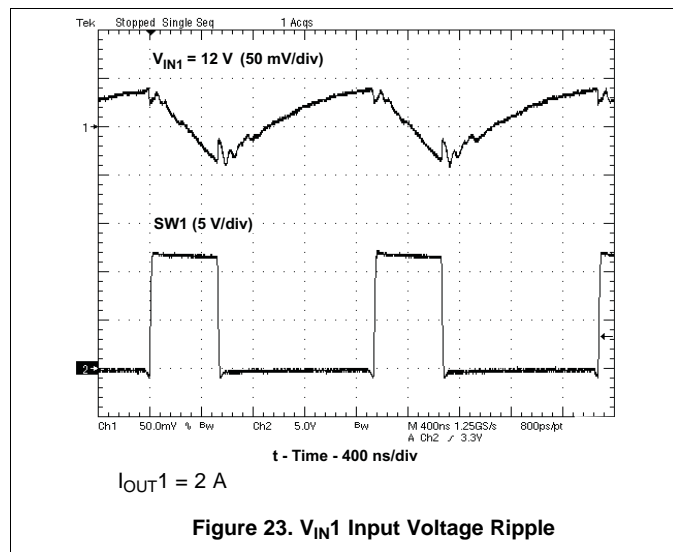

## 9 Power Supply Recommendations

The TPS54295 is designed to operate with an input voltage supply from 4.5 V to 18 V. This input power supply must be well regulated. Bulk capacitance may be required in addition to the ceramic bypass capacitors if the input supply is placed more than a few inches from the device. A 47- $\mu$ F electrolytic capacitor is a typical choice.

## 10 Layout

### 10.1 Layout Guidelines

1. Keep the input current loop as small as possible. And avoid the input switching current through the thermal pad.
2. Keep the SW node as physically small and short as possible to minimize parasitic capacitance and inductance and to minimize radiated emissions.
3. Keep analog and non-switching components away from switching components.
4. Make a single point connection from the signal ground to power ground.
5. Do not allow switching currents to flow under the device.
6. Keep the pattern lines for VINx and PGNDx broad.
7. Exposed pad of device must be soldered to PGND.
8. VREG5 capacitor must be placed near the device, and connected to GND.
9. Output capacitors must be connected with a broad pattern to the PGND.
10. Voltage feedback loops must be as short as possible, and preferably with ground shields.
11. Kelvin connections must be brought from the output to the feedback pin of the device.
12. Providing sufficient vias is preferable for VIN, SW, and PGND connections.
13. PCB pattern for VIN, SW, and PGND must be as broad as possible.
14. VIN capacitor must be placed as near as possible to the device.

## 10.2 Layout Example

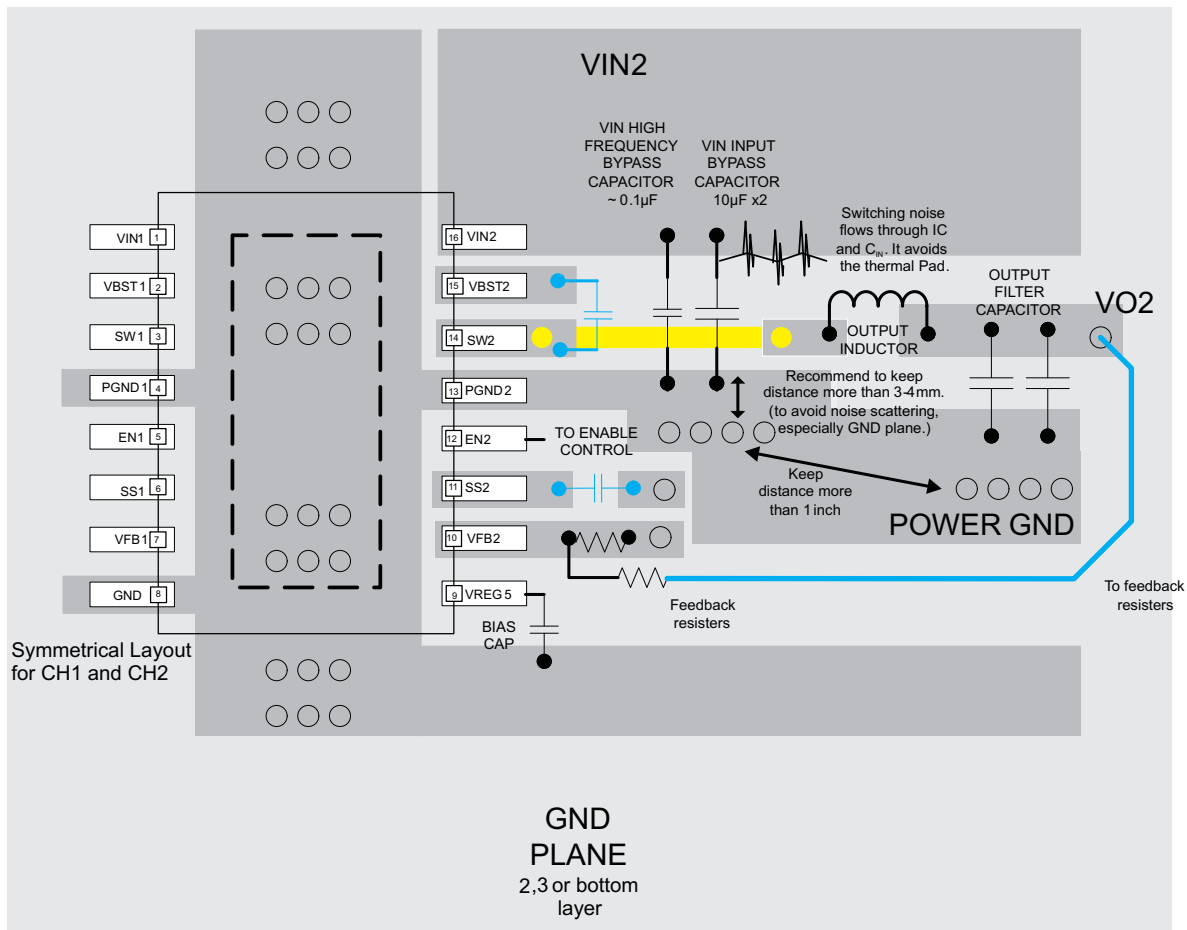

- Via to GND Plane
- Blue parts can be placed on the bottom side
- Connect the SWx pins through another layer with the inductor (yellow line)

Figure 25. TPS54295 PWP Package Layout

Layout Example (continued)

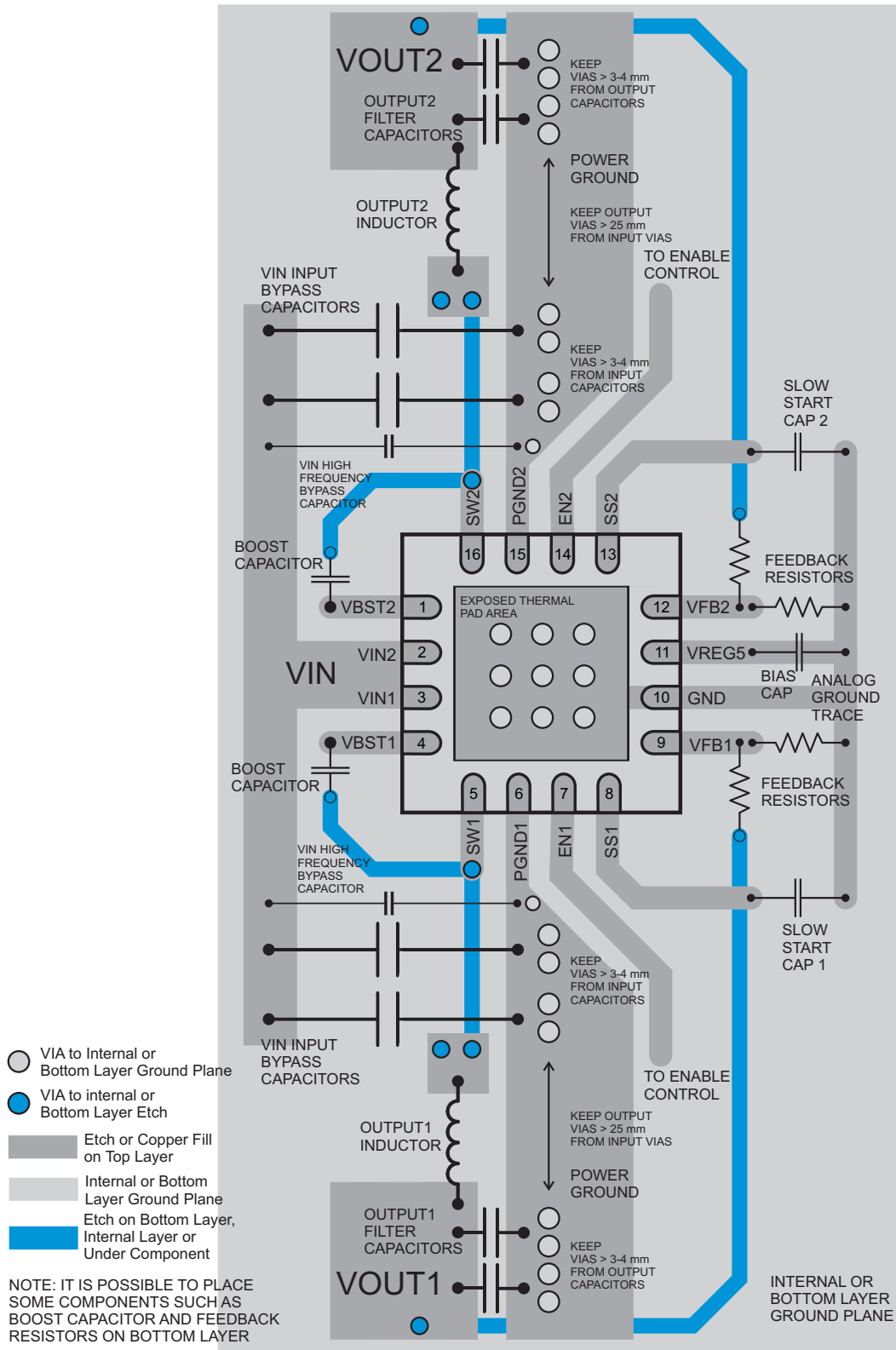

Figure 26. TPS54295 RSA Package Layout

### 10.3 Thermal Considerations

This 16-pin PWP package incorporates an exposed thermal pad. The thermal pad must be soldered directly to the printed-circuit board (PCB). After soldering, the PCB is used as a heat sink. In addition, through the use of thermal vias, the thermal pad can be attached directly to the appropriate copper plane shown in the electrical schematic for the device, or alternatively, can be attached to a special heat sink structure designed into the PCB. This design optimizes the heat transfer from the integrated circuit (IC).

For additional information on the exposed thermal pad and how to use the advantage of its heat dissipating abilities, see [PowerPAD Thermally Enhanced Package](#) and [PowerPAD Made Easy](#).

The exposed thermal pad dimensions for this package are shown in [Figure 27](#).

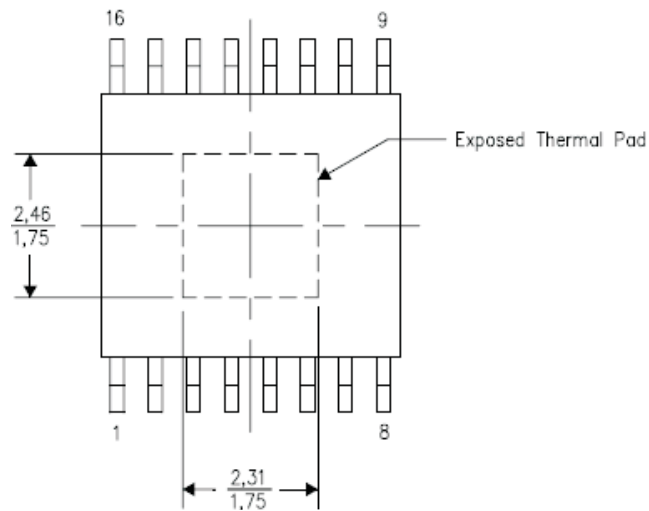

**Figure 27. Thermal Pad Dimensions**

## 11 器件和文档支持

### 11.1 器件支持

#### 11.1.1 开发支持

WEBENCH 工具 <http://www.ti.com/lsds/ti/analog/webench/overview.page>

### 11.2 文档支持

#### 11.2.1 相关文档

相关文档如下:

- 《[PowerPAD 耐热增强型封装](#)》 (文献编号: SLMA002)
- 《[PowerPAD 速成](#)》 (文献编号: SLMA004)

### 11.3 接收文档更新通知

如需接收文档更新通知, 请访问 [www.ti.com.cn](http://www.ti.com.cn) 网站上的器件产品文件夹。点击右上角的提醒我 (Alert me) 注册后, 即可每周定期收到已更改的产品信息。有关更改的详细信息, 请查阅已修订文档中包含的修订历史记录。

### 11.4 社区资源

The following links connect to TI community resources. Linked contents are provided "AS IS" by the respective contributors. They do not constitute TI specifications and do not necessarily reflect TI's views; see TI's [Terms of Use](#).

**TI E2E™ Online Community** *TI's Engineer-to-Engineer (E2E) Community*. Created to foster collaboration among engineers. At [e2e.ti.com](http://e2e.ti.com), you can ask questions, share knowledge, explore ideas and help solve problems with fellow engineers.

**Design Support** *TI's Design Support* Quickly find helpful E2E forums along with design support tools and contact information for technical support.

### 11.5 商标

D-CAP2, Eco-mode, E2E are trademarks of Texas Instruments.  
WEBENCH is a registered trademark of Texas Instruments.  
All other trademarks are the property of their respective owners.

### 11.6 静电放电警告



ESD 可能会损坏该集成电路。德州仪器 (TI) 建议通过适当的预防措施处理所有集成电路。如果不遵守正确的处理措施和安装程序, 可能会损坏集成电路。

ESD 的损坏小至导致微小的性能降级, 大至整个器件故障。精密的集成电路可能更容易受到损坏, 这是因为非常细微的参数更改都可能会导致器件与其发布的规格不相符。

### 11.7 Glossary

[SLYZ022](#) — *TI Glossary*.

This glossary lists and explains terms, acronyms, and definitions.

## 12 机械、封装和可订购信息

以下页中包括机械、封装和可订购信息。这些信息是针对指定器件可提供的最新数据。这些数据会在无通知且不对本文档进行修订的情况下发生改变。欲获得该数据表的浏览器版本, 请查阅左侧的导航栏。

## PACKAGING INFORMATION

| Orderable Device | Status<br>(1) | Package Type | Package Drawing | Pins | Package Qty | Eco Plan<br>(2) | Lead finish/<br>Ball material<br>(6) | MSL Peak Temp<br>(3) | Op Temp (°C) | Device Marking<br>(4/5) | Samples                 |
|------------------|---------------|--------------|-----------------|------|-------------|-----------------|--------------------------------------|----------------------|--------------|-------------------------|-------------------------|
| TPS54295PWP      | ACTIVE        | HTSSOP       | PWP             | 16   | 90          | RoHS & Green    | NIPDAU                               | Level-2-260C-1 YEAR  | -40 to 85    | PS54295                 | <a href="#">Samples</a> |
| TPS54295PWPR     | ACTIVE        | HTSSOP       | PWP             | 16   | 2000        | RoHS & Green    | NIPDAU                               | Level-2-260C-1 YEAR  | -40 to 85    | PS54295                 | <a href="#">Samples</a> |
| TPS54295RSAR     | ACTIVE        | QFN          | RSA             | 16   | 3000        | RoHS & Green    | NIPDAU                               | Level-1-260C-UNLIM   | -40 to 85    | TPS<br>54295            | <a href="#">Samples</a> |
| TPS54295RSAT     | ACTIVE        | QFN          | RSA             | 16   | 250         | RoHS & Green    | NIPDAU                               | Level-1-260C-UNLIM   | -40 to 85    | TPS<br>54295            | <a href="#">Samples</a> |

(1) The marketing status values are defined as follows:

**ACTIVE:** Product device recommended for new designs.

**LIFEBUY:** TI has announced that the device will be discontinued, and a lifetime-buy period is in effect.

**NRND:** Not recommended for new designs. Device is in production to support existing customers, but TI does not recommend using this part in a new design.

**PREVIEW:** Device has been announced but is not in production. Samples may or may not be available.

**OBSELETE:** TI has discontinued the production of the device.

(2) **RoHS:** TI defines "RoHS" to mean semiconductor products that are compliant with the current EU RoHS requirements for all 10 RoHS substances, including the requirement that RoHS substance do not exceed 0.1% by weight in homogeneous materials. Where designed to be soldered at high temperatures, "RoHS" products are suitable for use in specified lead-free processes. TI may reference these types of products as "Pb-Free".

**RoHS Exempt:** TI defines "RoHS Exempt" to mean products that contain lead but are compliant with EU RoHS pursuant to a specific EU RoHS exemption.

**Green:** TI defines "Green" to mean the content of Chlorine (Cl) and Bromine (Br) based flame retardants meet JS709B low halogen requirements of <=1000ppm threshold. Antimony trioxide based flame retardants must also meet the <=1000ppm threshold requirement.

(3) MSL, Peak Temp. - The Moisture Sensitivity Level rating according to the JEDEC industry standard classifications, and peak solder temperature.

(4) There may be additional marking, which relates to the logo, the lot trace code information, or the environmental category on the device.

(5) Multiple Device Markings will be inside parentheses. Only one Device Marking contained in parentheses and separated by a "~" will appear on a device. If a line is indented then it is a continuation of the previous line and the two combined represent the entire Device Marking for that device.

(6) Lead finish/Ball material - Orderable Devices may have multiple material finish options. Finish options are separated by a vertical ruled line. Lead finish/Ball material values may wrap to two lines if the finish value exceeds the maximum column width.

**Important Information and Disclaimer:**The information provided on this page represents TI's knowledge and belief as of the date that it is provided. TI bases its knowledge and belief on information provided by third parties, and makes no representation or warranty as to the accuracy of such information. Efforts are underway to better integrate information from third parties. TI has taken and



continues to take reasonable steps to provide representative and accurate information but may not have conducted destructive testing or chemical analysis on incoming materials and chemicals. TI and TI suppliers consider certain information to be proprietary, and thus CAS numbers and other limited information may not be available for release.

In no event shall TI's liability arising out of such information exceed the total purchase price of the TI part(s) at issue in this document sold by TI to Customer on an annual basis.

**TAPE AND REEL INFORMATION**

**QUADRANT ASSIGNMENTS FOR PIN 1 ORIENTATION IN TAPE**

\*All dimensions are nominal

| Device       | Package Type | Package Drawing | Pins | SPQ  | Reel Diameter (mm) | Reel Width W1 (mm) | A0 (mm) | B0 (mm) | K0 (mm) | P1 (mm) | W (mm) | Pin1 Quadrant |
|--------------|--------------|-----------------|------|------|--------------------|--------------------|---------|---------|---------|---------|--------|---------------|
| TPS54295PWPR | HTSSOP       | PWP             | 16   | 2000 | 330.0              | 12.4               | 6.9     | 5.6     | 1.6     | 8.0     | 12.0   | Q1            |
| TPS54295PWPR | HTSSOP       | PWP             | 16   | 2000 | 330.0              | 12.4               | 6.9     | 5.6     | 1.6     | 8.0     | 12.0   | Q1            |
| TPS54295RSAR | QFN          | RSA             | 16   | 3000 | 330.0              | 12.4               | 4.25    | 4.25    | 1.15    | 8.0     | 12.0   | Q2            |
| TPS54295RSAT | QFN          | RSA             | 16   | 250  | 180.0              | 12.4               | 4.25    | 4.25    | 1.15    | 8.0     | 12.0   | Q2            |

## TAPE AND REEL BOX DIMENSIONS



\*All dimensions are nominal

| Device       | Package Type | Package Drawing | Pins | SPQ  | Length (mm) | Width (mm) | Height (mm) |
|--------------|--------------|-----------------|------|------|-------------|------------|-------------|
| TPS54295PWPR | HTSSOP       | PWP             | 16   | 2000 | 356.0       | 356.0      | 35.0        |
| TPS54295PWPR | HTSSOP       | PWP             | 16   | 2000 | 350.0       | 350.0      | 43.0        |
| TPS54295RSAR | QFN          | RSA             | 16   | 3000 | 346.0       | 346.0      | 33.0        |
| TPS54295RSAT | QFN          | RSA             | 16   | 250  | 182.0       | 182.0      | 20.0        |

**TUBE**

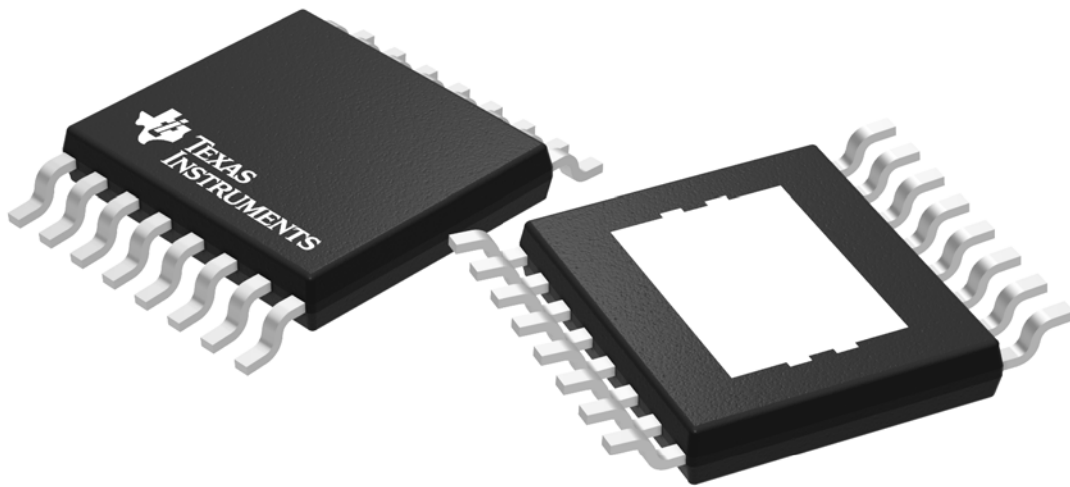

\*All dimensions are nominal

| Device      | Package Name | Package Type | Pins | SPQ | L (mm) | W (mm) | T (μm) | B (mm) |
|-------------|--------------|--------------|------|-----|--------|--------|--------|--------|
| TPS54295PWP | PWP          | HTSSOP       | 16   | 90  | 530    | 10.2   | 3600   | 3.5    |
| TPS54295PWP | PWP          | HTSSOP       | 16   | 90  | 530    | 10.2   | 3600   | 3.5    |

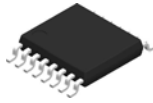

Images above are just a representation of the package family, actual package may vary.  
Refer to the product data sheet for package details.

# PWP0016C



# PACKAGE OUTLINE

## PowerPAD™ TSSOP - 1.2 mm max height

SMALL OUTLINE PACKAGE

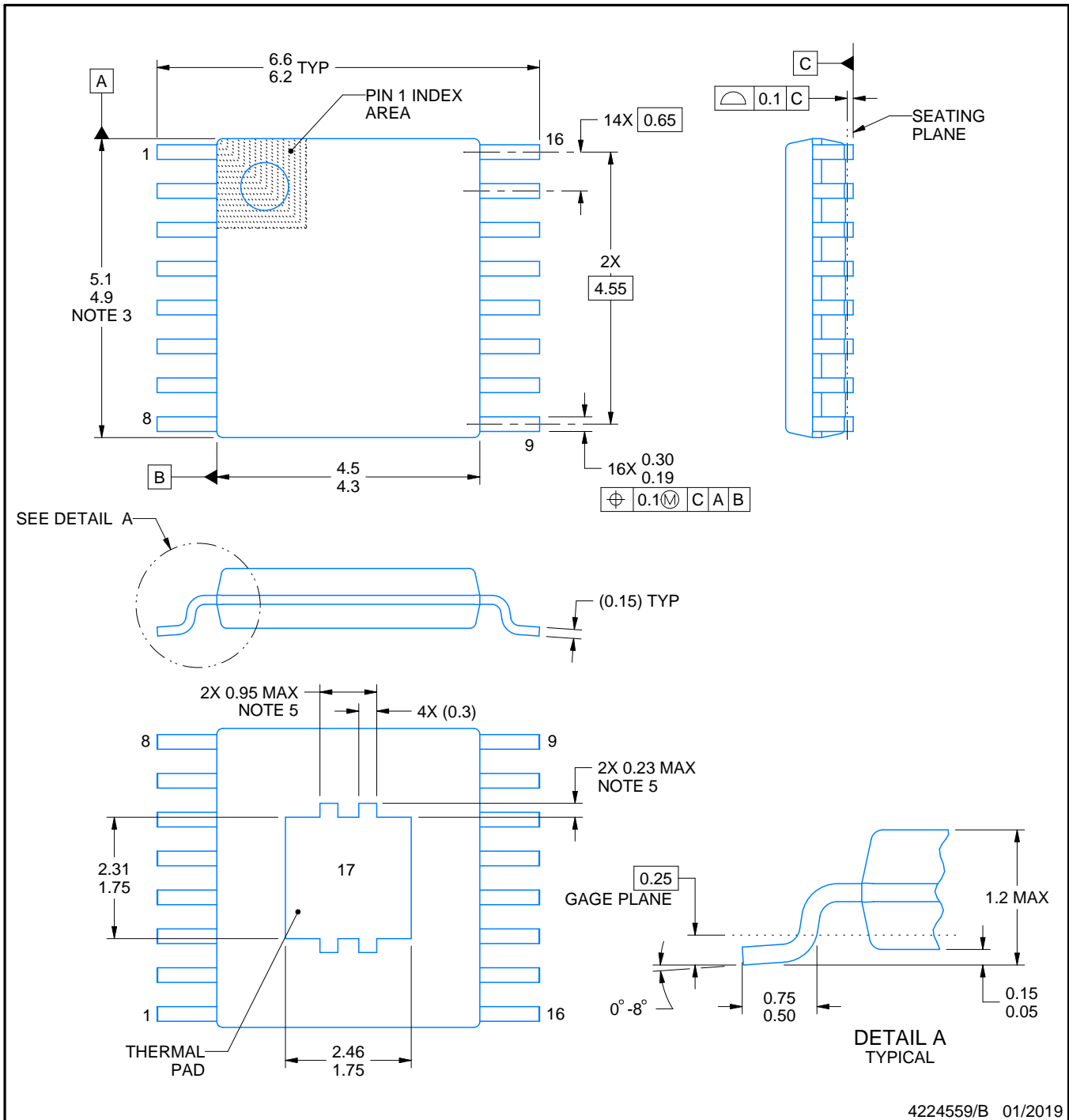

4224559/B 01/2019

**NOTES:**

PowerPAD is a trademark of Texas Instruments.

1. All linear dimensions are in millimeters. Any dimensions in parenthesis are for reference only. Dimensioning and tolerancing per ASME Y14.5M.
2. This drawing is subject to change without notice.
3. This dimension does not include mold flash, protrusions, or gate burrs. Mold flash, protrusions, or gate burrs shall not exceed 0.15 mm per side.
4. Reference JEDEC registration MO-153.
5. Features may differ or may not be present.

# EXAMPLE BOARD LAYOUT

PWP0016C

PowerPAD™ TSSOP - 1.2 mm max height

SMALL OUTLINE PACKAGE

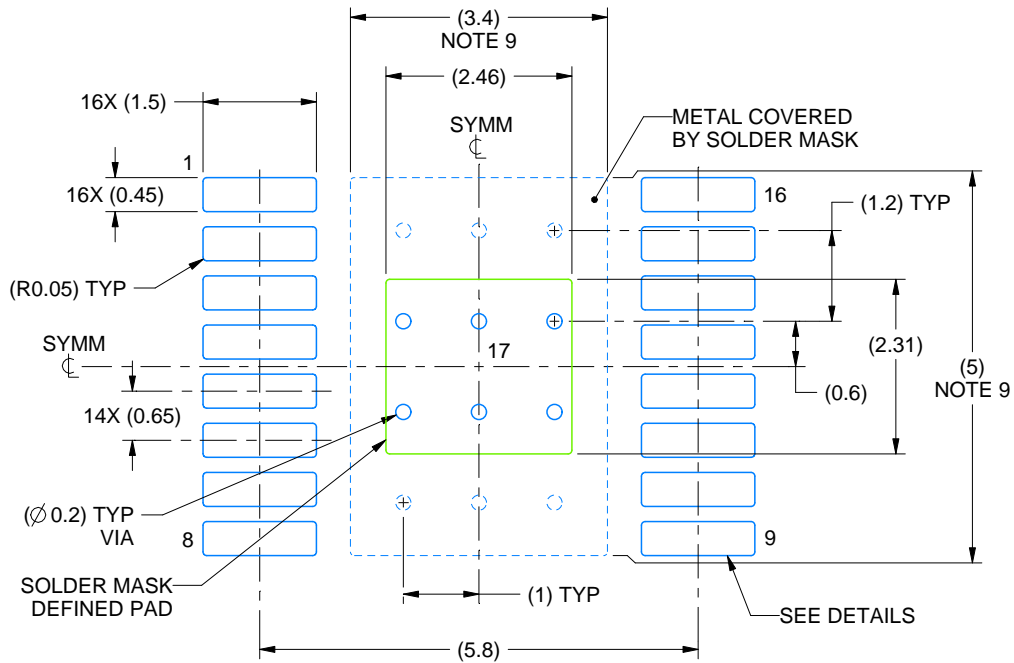

LAND PATTERN EXAMPLE  
EXPOSED METAL SHOWN  
SCALE: 10X

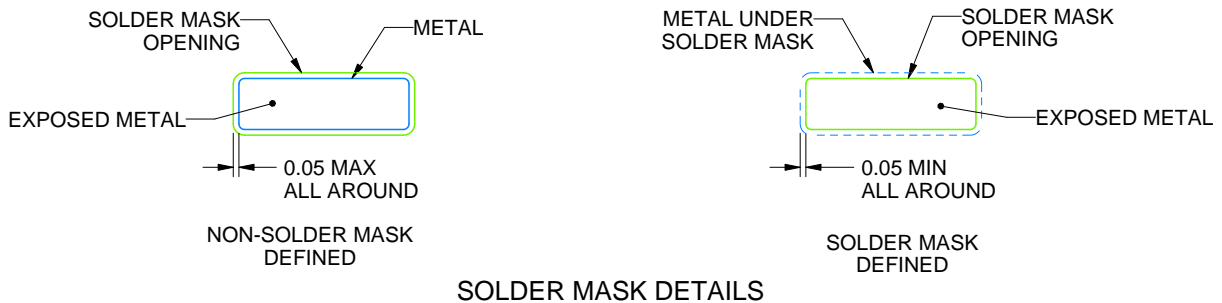

SOLDER MASK DETAILS

4224559/B 01/2019

NOTES: (continued)

6. Publication IPC-7351 may have alternate designs.
7. Solder mask tolerances between and around signal pads can vary based on board fabrication site.
8. This package is designed to be soldered to a thermal pad on the board. For more information, see Texas Instruments literature numbers SLMA002 ([www.ti.com/lit/slma002](http://www.ti.com/lit/slma002)) and SLMA004 ([www.ti.com/lit/slma004](http://www.ti.com/lit/slma004)).
9. Size of metal pad may vary due to creepage requirement.
10. Vias are optional depending on application, refer to device data sheet. It is recommended that vias under paste be filled, plugged or tented.

# EXAMPLE STENCIL DESIGN

PWP0016C

PowerPAD™ TSSOP - 1.2 mm max height

SMALL OUTLINE PACKAGE

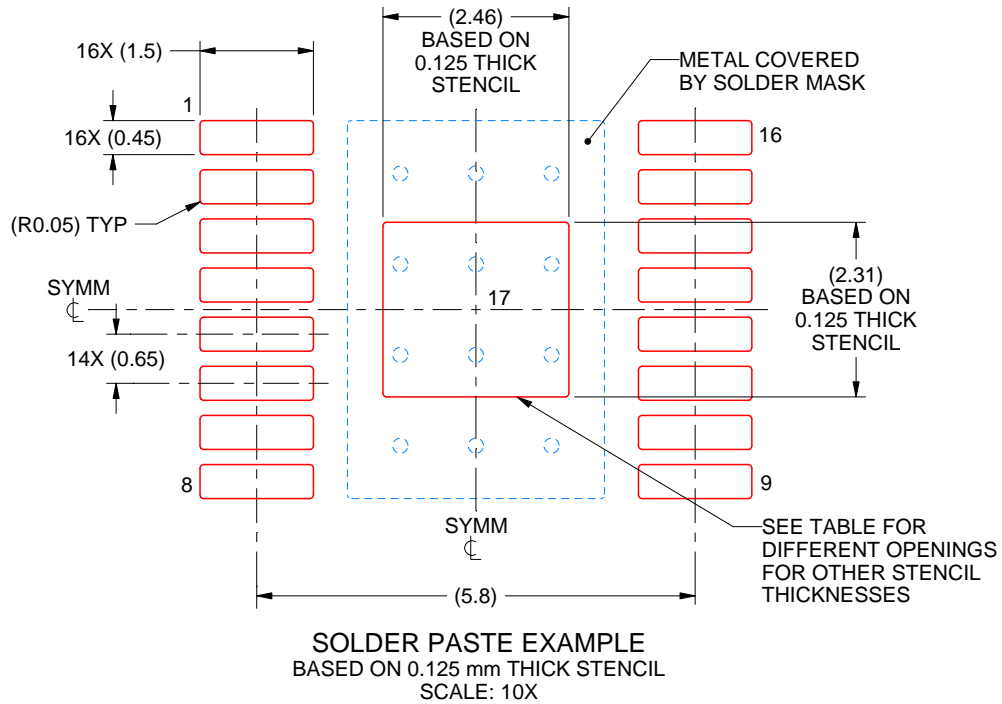

| STENCIL THICKNESS | SOLDER STENCIL OPENING |
|-------------------|------------------------|
| 0.1               | 2.75 X 2.58            |
| 0.125             | 2.46 X 2.31 (SHOWN)    |
| 0.15              | 2.25 X 2.11            |
| 0.175             | 2.08 X 1.95            |

4224559/B 01/2019

NOTES: (continued)

11. Laser cutting apertures with trapezoidal walls and rounded corners may offer better paste release. IPC-7525 may have alternate design recommendations.
12. Board assembly site may have different recommendations for stencil design.



## GENERIC PACKAGE VIEW

**RSA 16**

**VQFN - 1 mm max height**

4 x 4, 0.65 mm pitch

PLASTIC QUAD FLATPACK - NO LEAD

This image is a representation of the package family, actual package may vary.  
Refer to the product data sheet for package details.

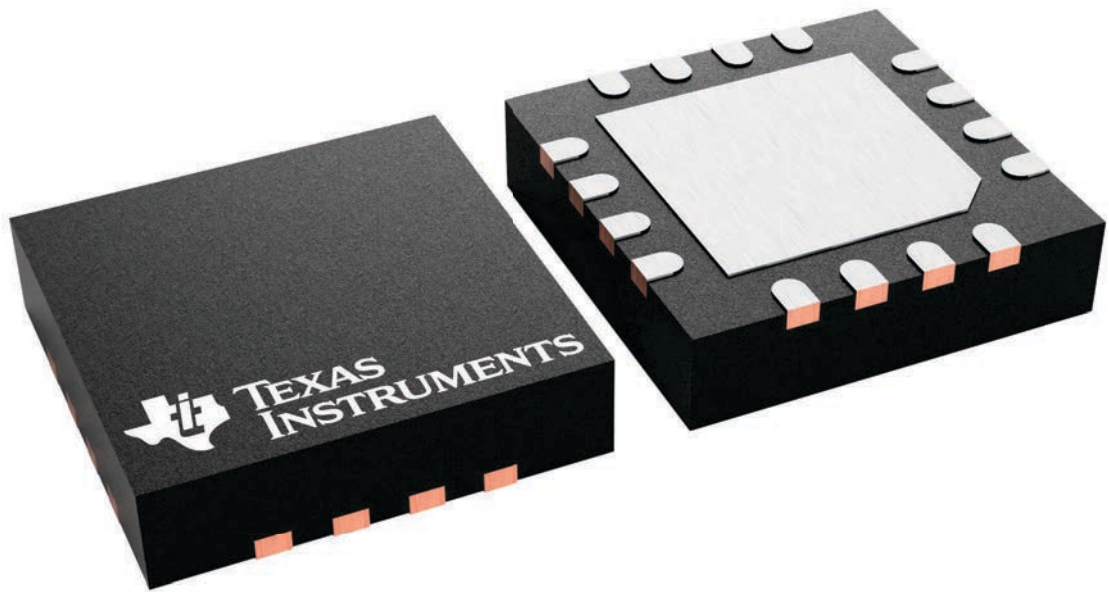

4230969/A

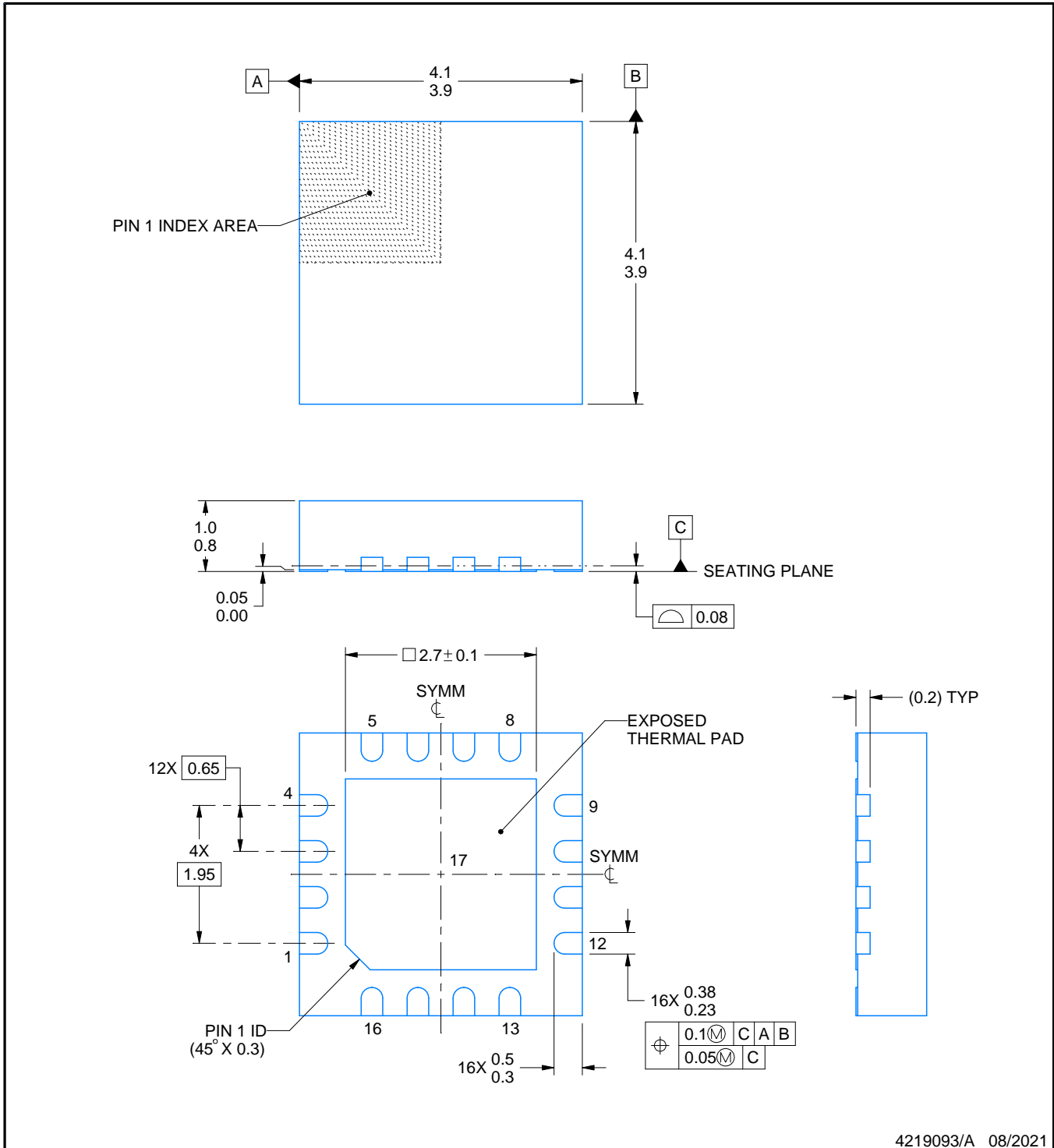
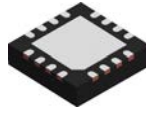

4219093/A 08/2021

NOTES:

1. All linear dimensions are in millimeters. Any dimensions in parenthesis are for reference only. Dimensioning and tolerancing per ASME Y14.5M.
2. This drawing is subject to change without notice.
3. The package thermal pad must be soldered to the printed circuit board for thermal and mechanical performance.
4. Reference JEDEC registration MO-220.





## 重要声明和免责声明

TI“按原样”提供技术和可靠性数据（包括数据表）、设计资源（包括参考设计）、应用或其他设计建议、网络工具、安全信息和其他资源，不保证没有瑕疵且不做任何明示或暗示的担保，包括但不限于对适销性、某特定用途方面的适用性或不侵犯任何第三方知识产权的暗示担保。

这些资源可供使用 TI 产品进行设计的熟练开发人员使用。您将自行承担以下全部责任：(1) 针对您的应用选择合适的 TI 产品，(2) 设计、验证并测试您的应用，(3) 确保您的应用满足相应标准以及任何其他功能安全、信息安全、监管或其他要求。

这些资源如有变更，恕不另行通知。TI 授权您仅可将这些资源用于研发本资源所述的 TI 产品的应用。严禁对这些资源进行其他复制或展示。您无权使用任何其他 TI 知识产权或任何第三方知识产权。您应全额赔偿因在这些资源的使用中对 TI 及其代表造成的任何索赔、损害、成本、损失和债务，TI 对此概不负责。

TI 提供的产品受 [TI 的销售条款](#) 或 [ti.com](#) 上其他适用条款/TI 产品随附的其他适用条款的约束。TI 提供这些资源并不会扩展或以其他方式更改 TI 针对 TI 产品发布的适用的担保或担保免责声明。

TI 反对并拒绝您可能提出的任何其他或不同的条款。

邮寄地址：Texas Instruments, Post Office Box 655303, Dallas, Texas 75265  
Copyright © 2024，德州仪器 (TI) 公司