

## CD4049UB 和 CD4050B CMOS 六路反相缓冲器和转换器

### 1 特性

- CD4049UB 反相
- CD4050B 同相
- 用于驱动 2 个 TTL 负载的高灌电流
- 高电平至低电平逻辑转换
- 在 20V 静态电流下经过 100% 测试
- 在全封装温度范围内，18V 时的最大输入电流为 1 $\mu$ A；18V 和 25°C 时为 100nA
- 5V、10V 和 15V 参数额定值

### 2 应用

- CMOS 至 DTL 或 TTL 十六进制转换器
- CMOS 灌电流或拉电流驱动器
- CMOS 高电平至低电平逻辑转换器

### 3 描述

CD4049UB 和 CD4050B 器件为反相和同相六路缓冲器，仅使用一个电源电压 ( $V_{CC}$ ) 即可实现逻辑电平转换。使用这些器件进行逻辑电平转换时，输入信号高电平 ( $V_{IH}$ ) 可以超过  $V_{CC}$  电源电压用于逻辑电平转换。这些器件可用作 CMOS 至 DTL 或 TTL 转换器，并可直接驱动两个 DTL 或 TTL 负载。(  $V_{CC} = 5V$ 、 $V_{OL} \leq 0.4V$  且  $I_{OL} \geq 3.3mA$ 。 )

#### 器件信息

| 器件型号 <sup>(1)</sup>      | 封装         | 封装尺寸 (标称值)       |
|--------------------------|------------|------------------|
| CD4049UBE、<br>CD4050BE   | PDIP (16)  | 6.35mm × 19.30mm |
| CD4049UBD、<br>CD4050BD   | SOIC (16)  | 9.90mm × 3.91mm  |
| CD4049UBDW、<br>CD4050BDW | SOIC (16)  | 10.30mm × 7.50mm |
| CD4049UBNS、<br>CD4050BNS | SO (16)    | 10.30mm × 5.30mm |
| CD4049UBPW、<br>CD4050BPW | TSSOP (16) | 5.00mm × 4.40mm  |

(1) 如需了解所有可用封装，请参阅数据表末尾的可订购产品附录。

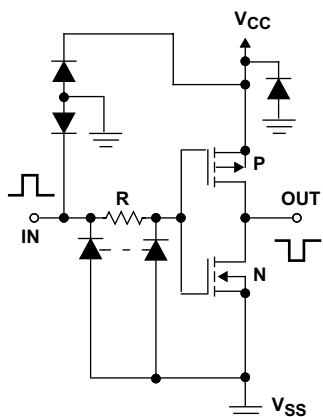

Copyright © 2016,  
Texas Instruments Incorporated

6 个相同单位中的 1 个

CD4049UB 的原理图

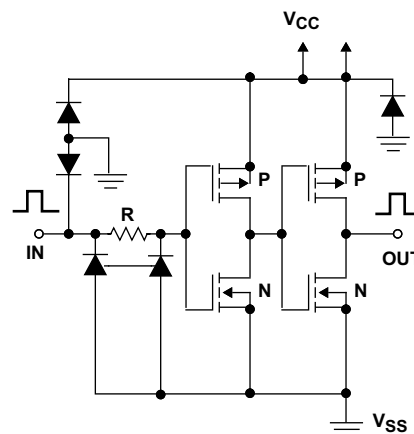

Copyright © 2016, Texas Instruments Incorporated

6 个相同单位中的 1 个

CD4050B 的原理图



## Table of Contents

|  |    |  |    |
|--|----|--|----|
| <b>1 特性</b> .....                                | 1  | 8.4 Device Functional Modes.....                                 | 14 |
| <b>2 应用</b> .....                                | 1  | <b>9 Application and Implementation</b> .....                    | 15 |
| <b>3 描述</b> .....                                | 1  | 9.1 Application Information.....                                 | 15 |
| <b>4 Revision History</b> .....                  | 2  | 9.2 Typical Application.....                                     | 15 |
| <b>5 Pin Configuration and Functions</b> .....   | 3  | <b>10 Power Supply Recommendations</b> .....                     | 16 |
| <b>6 Specifications</b> .....                    | 4  | <b>11 Layout</b> .....   | 16 |
| 6.1 Absolute Maximum Ratings.....                | 4  | 11.1 Layout Guidelines.....                                      | 16 |
| 6.2 ESD Ratings.....                             | 4  | 11.2 Layout Example.....   | 16 |
| 6.3 Recommended Operating Conditions.....        | 4  | <b>12 Device and Documentation Support</b> .....                 | 17 |
| 6.4 Thermal Information.....                     | 5  | 12.1 Documentation Support.....                                  | 17 |
| 6.5 Electrical Characteristics: DC.....          | 5  | 12.2 Related Links.....  | 17 |
| 6.6 Electrical Characteristics: AC.....          | 9  | 12.3 Receiving Notification of Documentation Updates..           | 17 |
| 6.7 Typical Characteristics.....                 | 10 | 12.4 支持资源.....   | 17 |
| <b>7 Parameter Measurement Information</b> ..... | 11 | 12.5 Trademarks.....   | 17 |
| 7.1 Test Circuits.....                           | 11 | 12.6 静电放电警告.....   | 17 |
| <b>8 Detailed Description</b> .....              | 13 | 12.7 术语表.....  | 17 |
| 8.1 Overview.....                                | 13 | <b>13 Mechanical, Packaging, and Orderable Information</b> ..... | 17 |
| 8.2 Functional Block Diagram.....                | 13 |  |    |
| 8.3 Feature Description.....                     | 13 |  |    |

## 4 Revision History

注：以前版本的页码可能与当前版本的页码不同

| <b>Changes from Revision J (September 2016) to Revision K (June 2020)</b> | <b>Page</b> |
|---|-------------|
| • 更新了整个文档中的表格、图和交叉参考的编号格式。.....   | 1           |
| • 使用正确的封装尺寸更新了器件信息表.....  | 1           |

| <b>Changes from Revision I (May 2004) to Revision J (September 2016)</b>  | <b>Page</b> |
|---|-------------|
| • 添加了 ESD 等级表、特性说明部分、器件功能模式、应用和实施部分、电源相关建议部分、布局部分、器件和文档支持部分以及机械、封装和可订购信息部分。.....  | 1           |
| • 删除了订购信息表；请参阅数据表末尾的 POA.....   | 1           |
| • Changed Storage temperature minimum value from 65 to - 65.....  | 4           |
| • Changed $R_{\theta JA}$ values for the CD4049UB device: D (SOIC) from 73 to 81.6, DW (SOIC) from 57 to 81.6, E (PDIP) from 67 to 49.5, NS (SO) from 64 to 84.3, and PW (TSSOP) from 108 to 108.9..... | 5           |
| • Changed $R_{\theta JA}$ values for the CD4050B device: D (SOIC) from 73 to 81.6, DW (SOIC) from 57 to 81.2, E (PDIP) from 67 to 49.7, NS (SO) from 64 to 83.8, and PW (TSSOP) from 108 to 108.4.....  | 5           |

## 5 Pin Configuration and Functions



图 5-1. CD4049UB D, DW, N, NS, and PW Packages 16-Pin SOIC, PDIP, SO, and TSSOP Top View



图 5-2. CD4050B D, DW, N, NS, and PW Packages 16-Pin SOIC, PDIP, SO, and TSSOP Top View

### Pin Functions: CD4049UB

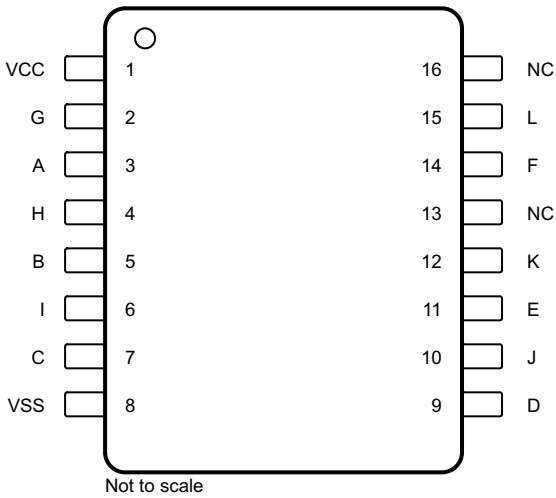
| PIN  |        | I/O | DESCRIPTION                       |
|------|--------|-----|-----------------------------------|
| NAME | NO.    |     |                                   |
| A    | 3      | I   | Input 1                           |
| B    | 5      | I   | Input 2                           |
| C    | 7      | I   | Input 3                           |
| D    | 9      | I   | Input 4                           |
| E    | 11     | I   | Input 5                           |
| F    | 14     | I   | Input 6                           |
| G    | 2      | O   | Inverting output 1. $G = \bar{A}$ |
| H    | 4      | O   | Inverting output 2. $H = \bar{B}$ |
| I    | 6      | O   | Inverting output 3. $I = \bar{C}$ |
| J    | 10     | O   | Inverting output 4. $J = \bar{D}$ |
| K    | 12     | O   | Inverting output 5. $K = \bar{E}$ |
| L    | 15     | O   | Inverting output 6. $L = \bar{F}$ |
| NC   | 13, 16 | —   | No connection                     |
| VCC  | 1      | —   | Power pin                         |
| VSS  | 8      | —   | Negative supply                   |

## Pin Functions: CD4050B

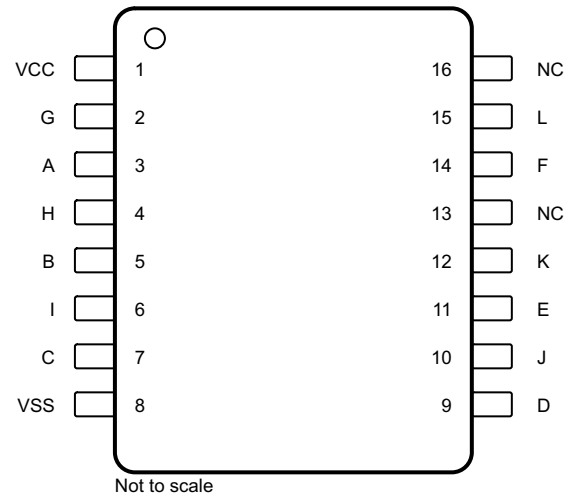
| PIN  |        | I/O | DESCRIPTION               |
|------|--------|-----|---------------------------|
| NAME | NO.    |     |                           |
| A    | 3      | I   | Input 1                   |
| B    | 5      | I   | Input 2                   |
| C    | 7      | I   | Input 3                   |
| D    | 9      | I   | Input 4                   |
| E    | 11     | I   | Input 5                   |
| F    | 14     | I   | Input 6                   |
| G    | 2      | O   | Inverting output 1. G = A |
| H    | 4      | O   | Inverting output 2. H = B |
| I    | 6      | O   | Inverting output 3. I = C |
| J    | 10     | O   | Inverting output 4. J = D |
| K    | 12     | O   | Inverting output 5. K = E |
| L    | 15     | O   | Inverting output 6. L = F |
| NC   | 13, 16 | —   | No connection             |
| VCC  | 1      | —   | Power pin                 |
| VSS  | 8      | —   | Negative supply           |

## 6 Specifications

### 6.1 Absolute Maximum Ratings

over operating free-air temperature range (unless otherwise noted)<sup>(1)</sup>

|                                    |                      | MIN   | MAX | UNIT |
|------------------------------------|----------------------|-------|-----|------|
| Supply voltage                     | VCC to VSS           | - 0.5 | 20  | V    |
| DC input current, $I_{IK}$         | Any one input        |       | ±10 | mA   |
| Lead temperature (soldering, 10 s) | SOIC, lead tips only |       | 265 | °C   |
| Junction temperature, $T_J$        |                      |       | 150 | °C   |
| Storage temperature, $T_{stg}$     |                      | - 65  | 150 | °C   |

- (1) Stresses beyond those listed under *Absolute Maximum Ratings* may cause permanent damage to the device. These are stress ratings only, which do not imply functional operation of the device at these or any other conditions beyond those indicated under [§ 6.3](#). Exposure to absolute-maximum-rated conditions for extended periods may affect device reliability.

### 6.2 ESD Ratings

|             |                         | VALUE  | UNIT  |
|-------------|-------------------------|--|-------|
| $V_{(ESD)}$ | Electrostatic discharge | Human-body model (HBM), per ANSI/ESDA/JEDEC JS-001 <sup>(1)</sup>              | ±1500 |
|             |                         | Charged-device model (CDM), per JEDEC specification JESD22-C101 <sup>(2)</sup> | ±1000 |

- (1) JEDEC document JEP155 states that 500-V HBM allows safe manufacturing with a standard ESD control process.  
(2) JEDEC document JEP157 states that 250-V CDM allows safe manufacturing with a standard ESD control process.

### 6.3 Recommended Operating Conditions

over operating free-air temperature range (unless otherwise noted)

|          |                       | MIN  | MAX | UNIT |
|----------|-----------------------|------|-----|------|
| $V_{CC}$ | Supply voltage        | 3    | 18  | V    |
| $T_A$    | Operating temperature | - 55 | 125 | °C   |

## 6.4 Thermal Information

| THERMAL METRIC <sup>(1)</sup>   | CD4049UB |           |          |         |            | CD4050B  |           |          |         |            | UNIT |
|---|----------|-----------|----------|---------|------------|----------|-----------|----------|---------|------------|------|
|   | D (SOIC) | DW (SOIC) | E (PDIP) | NS (SO) | PW (TSSOP) | D (SOIC) | DW (SOIC) | E (PDIP) | NS (SO) | PW (TSSOP) |      |
|   | 16 PINS  | 16 PINS   | 16 PINS  | 16 PINS | 16 PINS    | 16 PINS  | 16 PINS   | 16 PINS  | 16 PINS | 16 PINS    |      |
| $R_{\theta JA}$ Junction-to-ambient thermal resistance <sup>(2)</sup> | 81.6     | 81.6      | 49.5     | 84.3    | 108.9      | 81.6     | 81.2      | 49.7     | 83.8    | 108.4      | °C/W |
| $R_{\theta JC(top)}$ Junction-to-case (top) thermal resistance        | 41.5     | 44.5      | 36.8     | 43      | 43.7       | 41.5     | 44.1      | 37       | 42.5    | 43.2       | °C/W |
| $R_{\theta JB}$ Junction-to-board thermal resistance                  | 39       | 46.3      | 29.4     | 44.6    | 54         | 39       | 45.9      | 29.6     | 44.1    | 53.5       | °C/W |
| $\psi_{JT}$ Junction-to-top characterization parameter                | 10.7     | 16.5      | 21.7     | 12.8    | 4.6        | 10.7     | 16.1      | 21.9     | 12.5    | 4.5        | °C/W |
| $\psi_{JB}$ Junction-to-board characterization parameter              | 38.7     | 45.8      | 29.3     | 44.3    | 53.4       | 38.7     | 45.4      | 29.5     | 43.8    | 52.9       | °C/W |

- (1) For more information about traditional and new thermal metrics, see the [Semiconductor and IC Package Thermal Metrics](#) application report.
- (2) The package thermal impedance is calculated in accordance with JESD 51-7.

## 6.5 Electrical Characteristics: DC

| PARAMETER                              | TEST CONDITIONS                       | MIN            | TYP  | MAX | UNIT    |
|--|---------------------------------------|----------------|------|-----|---------|
| $I_{DD(Max)}$ Quiescent device current | $V_{IN} = 0$ or 5 V, $V_{CC} = 5$ V   | $T_A = -55$ °C |      | 1   | $\mu A$ |
|  |                                       | $T_A = -40$ °C |      | 1   |         |
|  |                                       | $T_A = 25$ °C  | 0.02 | 1   |         |
|  |                                       | $T_A = 85$ °C  |      | 30  |         |
|  |                                       | $T_A = 125$ °C |      | 30  |         |
|  | $V_{IN} = 0$ or 10 V, $V_{CC} = 10$ V | $T_A = -55$ °C |      | 2   |         |
|  |                                       | $T_A = -40$ °C |      | 2   |         |
|  |                                       | $T_A = 25$ °C  | 0.02 | 2   |         |
|  |                                       | $T_A = 85$ °C  |      | 60  |         |
|  |                                       | $T_A = 125$ °C |      | 60  |         |
|  | $V_{IN} = 0$ or 15 V, $V_{CC} = 4$ V  | $T_A = -55$ °C |      | 4   |         |
|  |                                       | $T_A = -40$ °C |      | 4   |         |
|  |                                       | $T_A = 25$ °C  | 0.02 | 4   |         |
|  |                                       | $T_A = 85$ °C  |      | 120 |         |
|  |                                       | $T_A = 125$ °C |      | 120 |         |
|  | $V_{IN} = 0$ or 20 V, $V_{CC} = 20$ V | $T_A = -55$ °C |      | 20  |         |
|  |                                       | $T_A = -40$ °C |      | 20  |         |
|  |                                       | $T_A = 25$ °C  | 0.04 | 20  |         |
|  |                                       | $T_A = 85$ °C  |      | 600 |         |
|  |                                       | $T_A = 125$ °C |      | 600 |         |

| PARAMETER               |                              | TEST CONDITIONS   |                         | MIN   | TYP  | MAX   | UNIT |
|-------------------------|------------------------------|---|-------------------------|-------|------|-------|------|
| I <sub>OL</sub> (Min)   | Output low (sink) current    | V <sub>OUT</sub> = 0.4 V, V <sub>IN</sub> = 0 or 5 V, V <sub>CC</sub> = 4.5 V | T <sub>A</sub> = -55 °C |       |      | 3.3   | mA   |
|                         |                              |   | T <sub>A</sub> = -40 °C |       |      | 3.1   |      |
|                         |                              |   | T <sub>A</sub> = 25 °C  | 2.6   | 5.2  |       |      |
|                         |                              |   | T <sub>A</sub> = 85 °C  |       |      | 2.1   |      |
|                         |                              |   | T <sub>A</sub> = 125 °C |       |      | 1.8   |      |
|                         |                              | V <sub>OUT</sub> = 0.4 V, V <sub>IN</sub> = 0 or 5 V, V <sub>CC</sub> = 5 V   | T <sub>A</sub> = -55 °C |       |      | 4     |      |
|                         |                              |   | T <sub>A</sub> = -40 °C |       |      | 3.8   |      |
|                         |                              |   | T <sub>A</sub> = 25 °C  | 3.2   | 6.4  |       |      |
|                         |                              |   | T <sub>A</sub> = 85 °C  |       |      | 2.9   |      |
|                         |                              |   | T <sub>A</sub> = 125 °C |       |      | 2.4   |      |
|                         |                              | V <sub>OUT</sub> = 0.5 V, V <sub>IN</sub> = 0 or 10 V, V <sub>CC</sub> = 10 V | T <sub>A</sub> = -55 °C |       |      | 10    |      |
|                         |                              |   | T <sub>A</sub> = -40 °C |       |      | 9.6   |      |
|                         |                              |   | T <sub>A</sub> = 25 °C  | 8     | 16   |       |      |
|                         |                              |   | T <sub>A</sub> = 85 °C  |       |      | 6.6   |      |
|                         |                              |   | T <sub>A</sub> = 125 °C |       |      | 5.6   |      |
|                         |                              | V <sub>OUT</sub> = 1.5 V, V <sub>IN</sub> = 0 or 15 V, V <sub>CC</sub> = 15 V | T <sub>A</sub> = -55 °C |       |      | 26    |      |
| T <sub>A</sub> = -40 °C |                              |   |                         | 25    |      |       |      |
| T <sub>A</sub> = 25 °C  | 24                           |   | 48                      |       |      |       |      |
| T <sub>A</sub> = 85 °C  |                              |   |                         | 20    |      |       |      |
| T <sub>A</sub> = 125 °C |                              |   |                         | 18    |      |       |      |
| I <sub>OH</sub> (Min)   | Output high (source) current | V <sub>OUT</sub> = 4.6 V, V <sub>IN</sub> = 0 or 5 V, V <sub>CC</sub> = 5 V   | T <sub>A</sub> = -55 °C |       |      | -0.81 | mA   |
|                         |                              |   | T <sub>A</sub> = -40 °C |       |      | -0.73 |      |
|                         |                              |   | T <sub>A</sub> = 25 °C  | -0.65 | -1.2 |       |      |
|                         |                              |   | T <sub>A</sub> = 85 °C  |       |      | -0.58 |      |
|                         |                              |   | T <sub>A</sub> = 125 °C |       |      | -0.48 |      |
|                         |                              | V <sub>OUT</sub> = 2.5 V, V <sub>IN</sub> = 0 or 5 V, V <sub>CC</sub> = 5 V   | T <sub>A</sub> = -55 °C |       |      | -2.6  |      |
|                         |                              |   | T <sub>A</sub> = -40 °C |       |      | -2.4  |      |
|                         |                              |   | T <sub>A</sub> = 25 °C  | -2.1  | -3.9 |       |      |
|                         |                              |   | T <sub>A</sub> = 85 °C  |       |      | -1.9  |      |
|                         |                              |   | T <sub>A</sub> = 125 °C |       |      | -1.55 |      |
|                         |                              | V <sub>OUT</sub> = 9.5 V, V <sub>IN</sub> = 0 or 10 V, V <sub>CC</sub> = 10 V | T <sub>A</sub> = -55 °C |       |      | -2    |      |
|                         |                              |   | T <sub>A</sub> = -40 °C |       |      | -1.8  |      |
|                         |                              |   | T <sub>A</sub> = 25 °C  | -1.65 | -3   |       |      |
|                         |                              |   | T <sub>A</sub> = 85 °C  |       |      | -1.35 |      |
|                         |                              |   | T <sub>A</sub> = 125 °C |       |      | -1.18 |      |
|                         |                              | V <sub>OUT</sub> = 1.3 V, V <sub>IN</sub> = 0 or 15 V, V <sub>CC</sub> = 15 V | T <sub>A</sub> = -55 °C |       |      | -5.2  |      |
| T <sub>A</sub> = -40 °C |                              |   |                         | -4.8  |      |       |      |
| T <sub>A</sub> = 25 °C  | -4.3                         |   | -8                      |       |      |       |      |
| T <sub>A</sub> = 85 °C  |                              |   |                         | -3.5  |      |       |      |
| T <sub>A</sub> = 125 °C |                              |   |                         | -3.1  |      |       |      |

| PARAMETER            |                              | TEST CONDITIONS   | MIN                               | TYP   | MAX | UNIT  |   |       |
|----------------------|------------------------------|---|-----------------------------------|-------|-----|-------|---|-------|
| $V_{OL}(\text{Max})$ | Out voltage low level        | $V_{IN} = 0$ or 5 V, $V_{CC} = 5$ V                         | $T_A = -55\text{ }^\circ\text{C}$ |       |     | 0.05  | V |       |
|                      |                              |   | $T_A = -40\text{ }^\circ\text{C}$ |       |     | 0.05  |   |       |
|                      |                              |   | $T_A = 25\text{ }^\circ\text{C}$  |       | 0   | 0.05  |   |       |
|                      |                              |   | $T_A = 85\text{ }^\circ\text{C}$  |       |     | 0.05  |   |       |
|                      |                              |   | $T_A = 125\text{ }^\circ\text{C}$ |       |     | 0.05  |   |       |
|                      |                              | $V_{IN} = 0$ or 10 V, $V_{CC} = 10$ V                       | $T_A = -55\text{ }^\circ\text{C}$ |       |     |       |   | 0.05  |
|                      |                              |   | $T_A = -40\text{ }^\circ\text{C}$ |       |     |       |   | 0.05  |
|                      |                              |   | $T_A = 25\text{ }^\circ\text{C}$  |       | 0   | 0.05  |   |       |
|                      |                              |   | $T_A = 85\text{ }^\circ\text{C}$  |       |     | 0.05  |   |       |
|                      |                              |   | $T_A = 125\text{ }^\circ\text{C}$ |       |     | 0.05  |   |       |
|                      |                              | $V_{IN} = 0$ or 15 V, $V_{CC} = 15$ V                       | $T_A = -55\text{ }^\circ\text{C}$ |       |     |       |   | 0.05  |
|                      |                              |   | $T_A = -40\text{ }^\circ\text{C}$ |       |     |       |   | 0.05  |
|                      |                              |   | $T_A = 25\text{ }^\circ\text{C}$  |       | 0   | 0.05  |   |       |
|                      |                              |   | $T_A = 85\text{ }^\circ\text{C}$  |       |     | 0.05  |   |       |
|                      |                              |   | $T_A = 125\text{ }^\circ\text{C}$ |       |     | 0.05  |   |       |
| $V_{OH}(\text{Min})$ | Output voltage high level    | $V_{IN} = 0$ or 5 V, $V_{CC} = 5$ V                         | $T_A = -55\text{ }^\circ\text{C}$ |       |     | 4.95  | V |       |
|                      |                              |   | $T_A = -40\text{ }^\circ\text{C}$ |       |     | 4.95  |   |       |
|                      |                              |   | $T_A = 25\text{ }^\circ\text{C}$  | 4.95  | 5   |       |   |       |
|                      |                              |   | $T_A = 85\text{ }^\circ\text{C}$  |       |     | 4.95  |   |       |
|                      |                              |   | $T_A = 125\text{ }^\circ\text{C}$ |       |     | 4.95  |   |       |
|                      |                              | $V_{IN} = 0$ or 10 V, $V_{CC} = 10$ V                       | $T_A = -55\text{ }^\circ\text{C}$ |       |     |       |   | 9.95  |
|                      |                              |   | $T_A = -40\text{ }^\circ\text{C}$ |       |     |       |   | 9.95  |
|                      |                              |   | $T_A = 25\text{ }^\circ\text{C}$  | 9.95  | 10  |       |   |       |
|                      |                              |   | $T_A = 85\text{ }^\circ\text{C}$  |       |     | 9.95  |   |       |
|                      |                              |   | $T_A = 125\text{ }^\circ\text{C}$ |       |     | 9.95  |   |       |
|                      |                              | $V_{IN} = 0$ or 15 V, $V_{CC} = 15$ V                       | $T_A = -55\text{ }^\circ\text{C}$ |       |     |       |   | 14.95 |
|                      |                              |   | $T_A = -40\text{ }^\circ\text{C}$ |       |     |       |   | 14.95 |
|                      |                              |   | $T_A = 25\text{ }^\circ\text{C}$  | 14.95 | 15  |       |   |       |
|                      |                              |   | $T_A = 85\text{ }^\circ\text{C}$  |       |     | 14.95 |   |       |
|                      |                              |   | $T_A = 125\text{ }^\circ\text{C}$ |       |     | 14.95 |   |       |
| $V_{IL}(\text{Max})$ | Input low voltage (CD4049UB) | $V_{OUT} = 4.5$ V, $V_{CC} = 5$ V, Full temperature range   |                                   |       | 1   | V     |   |       |
|                      |                              | $V_{OUT} = 9$ V, $V_{CC} = 10$ V, Full temperature range    |                                   |       | 2   |       |   |       |
|                      |                              | $V_{OUT} = 13.5$ V, $V_{CC} = 15$ V, Full temperature range |                                   |       | 2.5 |       |   |       |
|                      | Input low voltage (CD4050B)  | $V_{OUT} = 0.5$ V, $V_{CC} = 5$ V, Full temperature range   |                                   |       | 1.5 |       |   |       |
|                      |                              | $V_{OUT} = 1$ V, $V_{CC} = 10$ V, Full temperature range    |                                   |       | 3   |       |   |       |
|                      |                              | $V_{OUT} = 1.5$ V, $V_{CC} = 15$ V, Full temperature range  |                                   |       | 4   |       |   |       |

| PARAMETER  | TEST CONDITIONS                                     | MIN                      | TYP               | MAX | UNIT |      |      |
|--|---|--------------------------|-------------------|-----|------|------|------|
| V <sub>IH</sub> (Min)    Input high voltage (CD4049UB) | V <sub>OUT</sub> = 0.5 V, V <sub>CC</sub> = 5 V     | T <sub>A</sub> = - 55 °C |                   |     | 4    | V    |      |
|  |   | T <sub>A</sub> = - 40 °C |                   |     | 4    |      |      |
|  |   | T <sub>A</sub> = 25 °C   | 4                 |     |      |      |      |
|  |   | T <sub>A</sub> = 85 °C   |                   |     | 4    |      |      |
|  |   | T <sub>A</sub> = 125 °C  |                   |     | 4    |      |      |
|  | V <sub>OUT</sub> = 1 V, V <sub>CC</sub> = 10 V      | T <sub>A</sub> = - 55 °C |                   |     |      |      | 8    |
|  |   | T <sub>A</sub> = - 40 °C |                   |     |      |      | 8    |
|  |   | T <sub>A</sub> = 25 °C   | 8                 |     |      |      |      |
|  |   | T <sub>A</sub> = 85 °C   |                   |     |      |      | 8    |
|  |   | T <sub>A</sub> = 125 °C  |                   |     |      |      | 8    |
|  | V <sub>OUT</sub> = 1.5 V, V <sub>CC</sub> = 15 V    | T <sub>A</sub> = - 55 °C |                   |     |      |      | 12.5 |
|  |   | T <sub>A</sub> = - 40 °C |                   |     |      |      | 12.5 |
|  |   | T <sub>A</sub> = 25 °C   | 12.5              |     |      |      |      |
|  |   | T <sub>A</sub> = 85 °C   |                   |     |      |      | 12.5 |
|  |   | T <sub>A</sub> = 125 °C  |                   |     |      |      | 12.5 |
| V <sub>IH</sub> Input high voltage (CD4050B)           | V <sub>OUT</sub> = 4.5 V, V <sub>CC</sub> = 5 V     | T <sub>A</sub> = - 55 °C |                   |     |      | 3.5  | V    |
|  |   | T <sub>A</sub> = - 40 °C |                   |     |      | 3.5  |      |
|  |   | T <sub>A</sub> = 25 °C   | 3.5               |     |      |      |      |
|  |   | T <sub>A</sub> = 85 °C   |                   |     |      | 3.5  |      |
|  |   | T <sub>A</sub> = 125 °C  |                   |     |      | 3.5  |      |
|  | V <sub>OUT</sub> = 9 V, V <sub>CC</sub> = 10 V      | T <sub>A</sub> = - 55 °C |                   |     |      | 7    |      |
|  |   | T <sub>A</sub> = - 40 °C |                   |     |      | 7    |      |
|  |   | T <sub>A</sub> = 25 °C   | 7                 |     |      |      |      |
|  |   | T <sub>A</sub> = 85 °C   |                   |     |      | 7    |      |
|  |   | T <sub>A</sub> = 125 °C  |                   |     |      | 7    |      |
|  | V <sub>OUT</sub> = 13.5 V, V <sub>CC</sub> = 15 V   | T <sub>A</sub> = - 55 °C |                   |     |      | 11   |      |
|  |   | T <sub>A</sub> = - 40 °C |                   |     |      | 11   |      |
|  |   | T <sub>A</sub> = 25 °C   | 11                |     |      |      |      |
|  |   | T <sub>A</sub> = 85 °C   |                   |     |      | 11   |      |
|  |   | T <sub>A</sub> = 125 °C  |                   |     |      | 11   |      |
| I <sub>IN</sub> (Max)    Input current                 | V <sub>IN</sub> = 0 or 18 V, V <sub>CC</sub> = 18 V | T <sub>A</sub> = - 55 °C |                   |     |      | ±0.1 | µA   |
|  |   | T <sub>A</sub> = - 40 °C |                   |     |      | ±0.1 |      |
|  |   | T <sub>A</sub> = 25 °C   | ±10 <sup>-5</sup> |     |      | ±0.1 |      |
|  |   | T <sub>A</sub> = 85 °C   |                   |     |      | ±1   |      |
|  |   | T <sub>A</sub> = 125 °C  |                   |     |      | ±1   |      |



## 6.6 Electrical Characteristics: AC

 $T_A = 25^\circ\text{C}$ , Input  $t_r$  and  $t_f = 20\text{ ns}$ ,  $C_L = 50\text{ pF}$ ,  $R_L = 200\text{ k}\Omega$  (unless otherwise noted)

| PARAMETER |  | TEST CONDITIONS                              | MIN | TYP | MAX  | UNIT |
|-----------|--|--|-----|-----|------|------|
| $t_{PLH}$ | Propagation delay time<br>Low to high (CD4049UB) | $V_{IN} = 5\text{ V}, V_{CC} = 5\text{ V}$   |     | 60  | 120  | ns   |
|           |  | $V_{IN} = 10\text{ V}, V_{CC} = 10\text{ V}$ |     | 32  | 65   |      |
|           |  | $V_{IN} = 10\text{ V}, V_{CC} = 5\text{ V}$  |     | 45  | 90   |      |
|           |  | $V_{IN} = 15\text{ V}, V_{CC} = 15\text{ V}$ |     | 25  | 50   |      |
|           |  | $V_{IN} = 15\text{ V}, V_{CC} = 5\text{ V}$  |     | 45  | 90   |      |
|           | Propagation delay time<br>Low to high (CD4050B)  | $V_{IN} = 5\text{ V}, V_{CC} = 5\text{ V}$   |     | 70  | 140  | ns   |
|           |  | $V_{IN} = 10\text{ V}, V_{CC} = 10\text{ V}$ |     | 40  | 80   |      |
|           |  | $V_{IN} = 10\text{ V}, V_{CC} = 5\text{ V}$  |     | 45  | 90   |      |
|           |  | $V_{IN} = 15\text{ V}, V_{CC} = 15\text{ V}$ |     | 30  | 60   |      |
|           |  | $V_{IN} = 15\text{ V}, V_{CC} = 5\text{ V}$  |     | 40  | 80   |      |
| $t_{PHL}$ | Propagation delay time<br>High to low (CD4049UB) | $V_{IN} = 5\text{ V}, V_{CC} = 5\text{ V}$   |     | 32  | 65   | ns   |
|           |  | $V_{IN} = 10\text{ V}, V_{CC} = 10\text{ V}$ |     | 20  | 40   |      |
|           |  | $V_{IN} = 10\text{ V}, V_{CC} = 5\text{ V}$  |     | 15  | 30   |      |
|           |  | $V_{IN} = 15\text{ V}, V_{CC} = 15\text{ V}$ |     | 15  | 30   |      |
|           |  | $V_{IN} = 15\text{ V}, V_{CC} = 5\text{ V}$  |     | 10  | 20   |      |
|           | Propagation delay time<br>High to low (CD4050B)  | $V_{IN} = 5\text{ V}, V_{CC} = 5\text{ V}$   |     | 55  | 110  | ns   |
|           |  | $V_{IN} = 10\text{ V}, V_{CC} = 10\text{ V}$ |     | 22  | 55   |      |
|           |  | $V_{IN} = 10\text{ V}, V_{CC} = 5\text{ V}$  |     | 50  | 100  |      |
|           |  | $V_{IN} = 15\text{ V}, V_{CC} = 15\text{ V}$ |     | 15  | 30   |      |
|           |  | $V_{IN} = 15\text{ V}, V_{CC} = 5\text{ V}$  |     | 50  | 100  |      |
| $t_{TLH}$ | Transition time<br>Low to high                   | $V_{IN} = 5\text{ V}, V_{CC} = 5\text{ V}$   |     | 80  | 160  | ns   |
|           |  | $V_{IN} = 10\text{ V}, V_{CC} = 10\text{ V}$ |     | 40  | 80   |      |
|           |  | $V_{IN} = 15\text{ V}, V_{CC} = 15\text{ V}$ |     | 30  | 60   |      |
| $t_{THL}$ | Transition time<br>High to low                   | $V_{IN} = 5\text{ V}, V_{CC} = 5\text{ V}$   |     | 30  | 60   | ns   |
|           |  | $V_{IN} = 10\text{ V}, V_{CC} = 10\text{ V}$ |     | 20  | 40   |      |
|           |  | $V_{IN} = 15\text{ V}, V_{CC} = 15\text{ V}$ |     | 15  | 30   |      |
| $C_{IN}$  | Input capacitance (CD4049UB)                     |  |     | 15  | 22.5 | pF   |
|           | Input capacitance (CD4050B)                      |  |     | 5   | 7.5  | pF   |

## 6.7 Typical Characteristics



图 6-1. Minimum and Maximum Voltage Transfer Characteristics for CD4049UB



图 6-2. Minimum and Maximum Voltage Transfer Characteristics for CD4050B

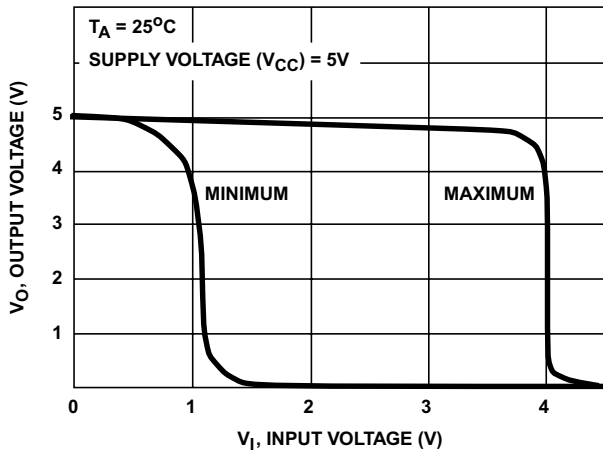

图 6-3. Typical Output Low (Sink) Current Characteristics

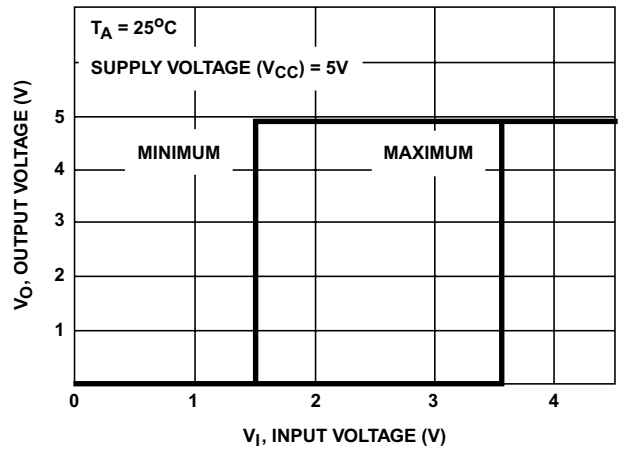

图 6-4. Minimum Output Low (Sink) Current Drain Characteristics

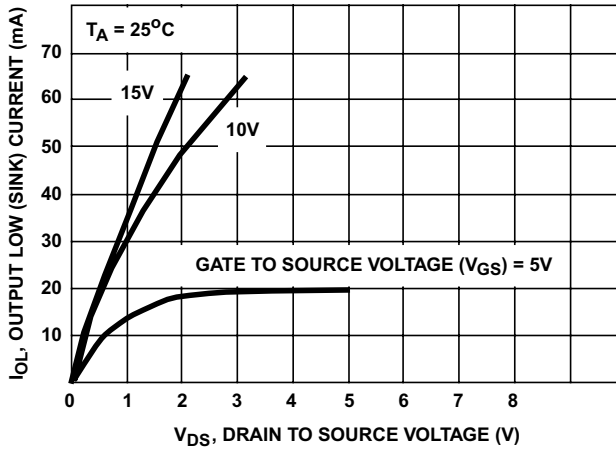

图 6-5. Typical Output High (Source) Current Characteristics

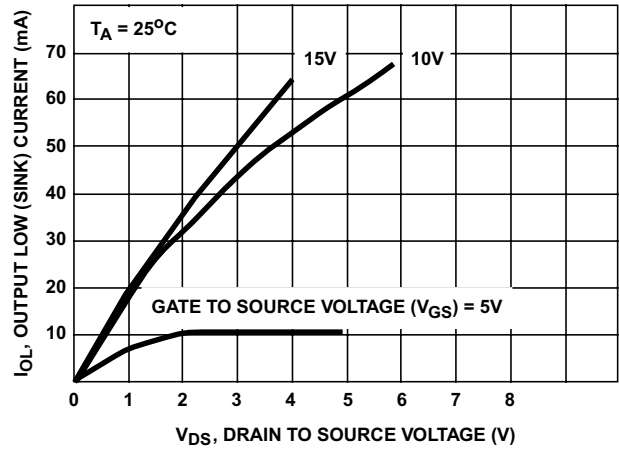

图 6-6. Minimum Output High (Source) Current Characteristics

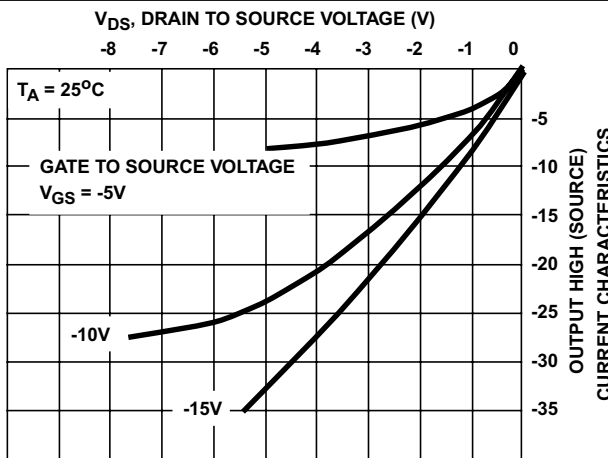

图 6-7. Typical Voltage Transfer Characteristics as a Function of Temperature for CD4049UB

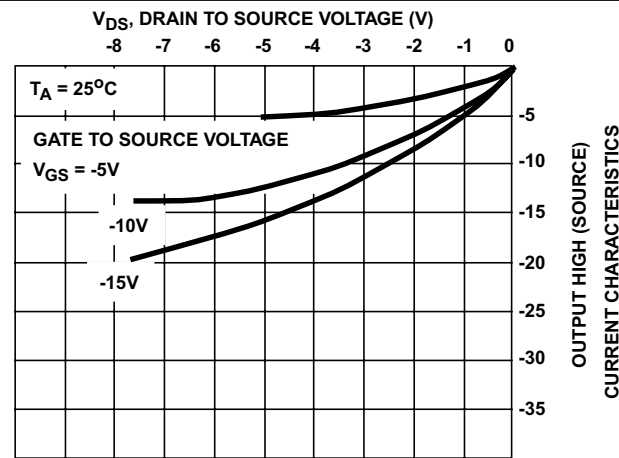

图 6-8. Typical Voltage Transfer Characteristics as a Function of Temperature for CD4050B

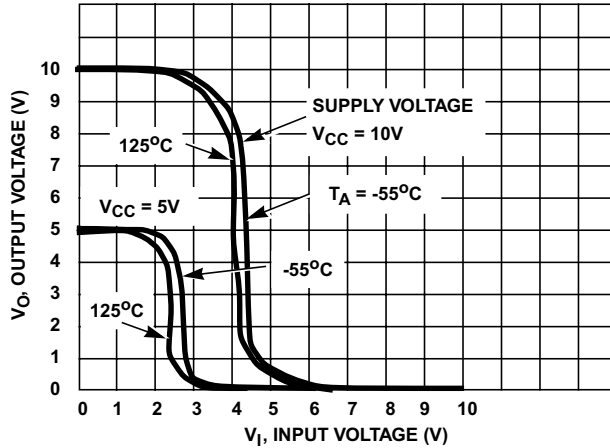

图 6-9. Typical Power Dissipation versus Frequency Characteristics

## 7 Parameter Measurement Information

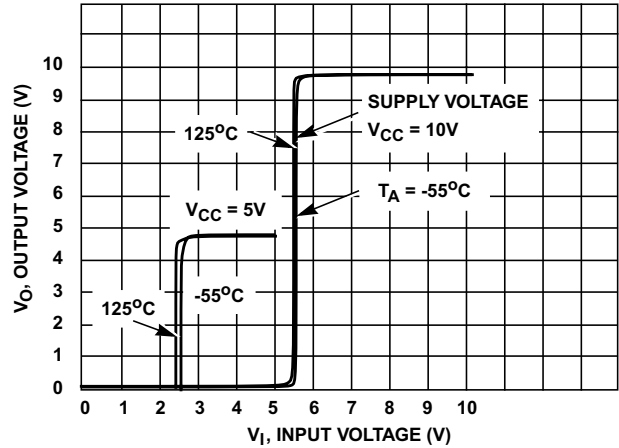
### 7.1 Test Circuits

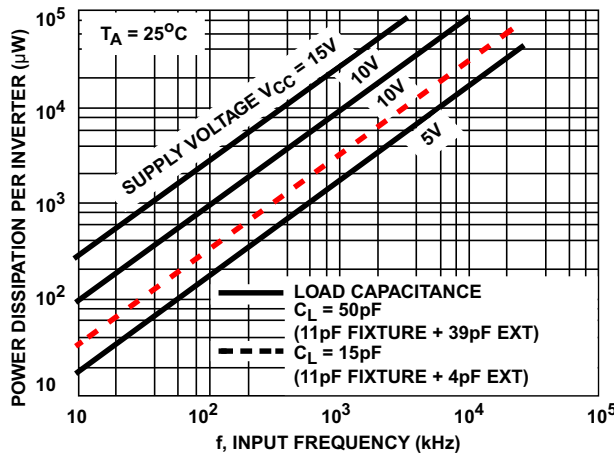

图 7-1. Quiescent Device Current Test Circuit



Test any one input with other inputs at V<sub>CC</sub> or V<sub>SS</sub>.

图 7-2. Input Voltage Test Circuit

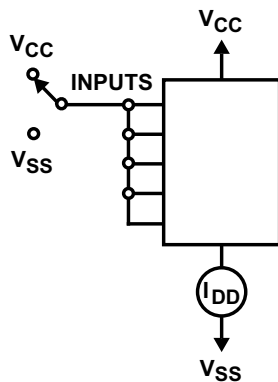
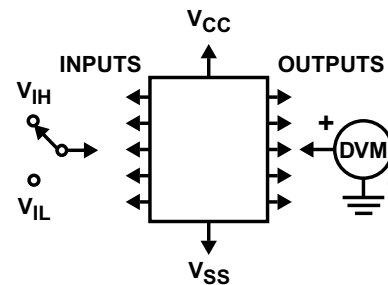
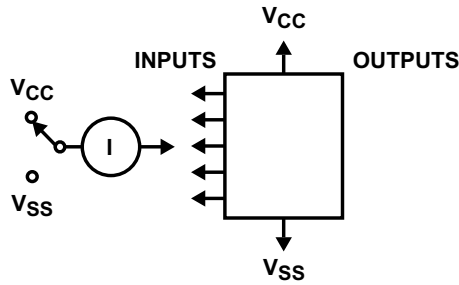

Measure inputs sequentially, to both VCC and VSS connect all unused inputs to either VCC or VSS.

图 7-3. Input Current Test Circuit

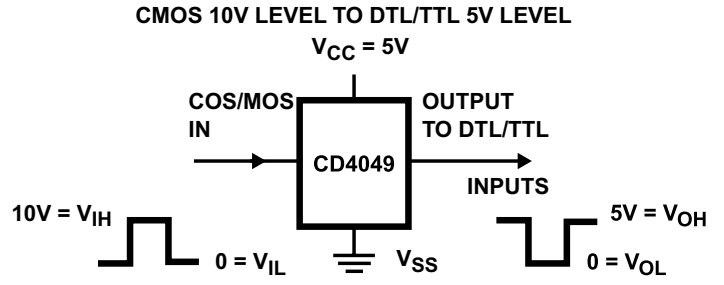

IN Pin: A, B, C, D, E, or F  
 OUT Pin: G, H, I, J, K, or L  
 VCC Pin  
 VSS Pin

图 7-4. Logic Level Conversion Application

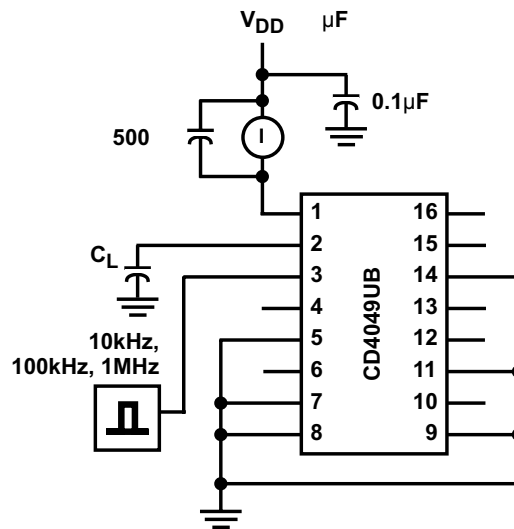

$C_L$  includes fixture capacitance.

图 7-5. Dynamic Power Dissipation Test Circuits

## 8 Detailed Description

### 8.1 Overview

The CD4049UB device is an inverting hex buffer; the CD4050B device is a noninverting hex buffer. These devices do logic-level conversions and have a high sink current that can drive two TTL loads. These devices also have low input current of 1  $\mu\text{A}$  across the full temperature range at 18 V.

The CD4049UB and CD4050B devices are designated as replacements for CD4009UB and CD4010B devices, respectively. Because the CD4049UB and CD4050B require only one power supply, they are preferred over the CD4009UB and CD4010B and should be used in place of the CD4009UB and CD4010B in all inverter, current driver, or logic-level conversion applications. In these applications the CD4049UB and CD4050B are pin compatible with the CD4009UB and CD4010B respectively, and can be substituted for these devices in existing as well as in new designs. Pin 16 (NC) is not connected internally on the CD4049UB or CD4050B, therefore, connection to this terminal is of no consequence to circuit operation. TI recommends the CD4069UB hex inverter is recommended for applications not requiring high sink-current or voltage conversion.

### 8.2 Functional Block Diagram

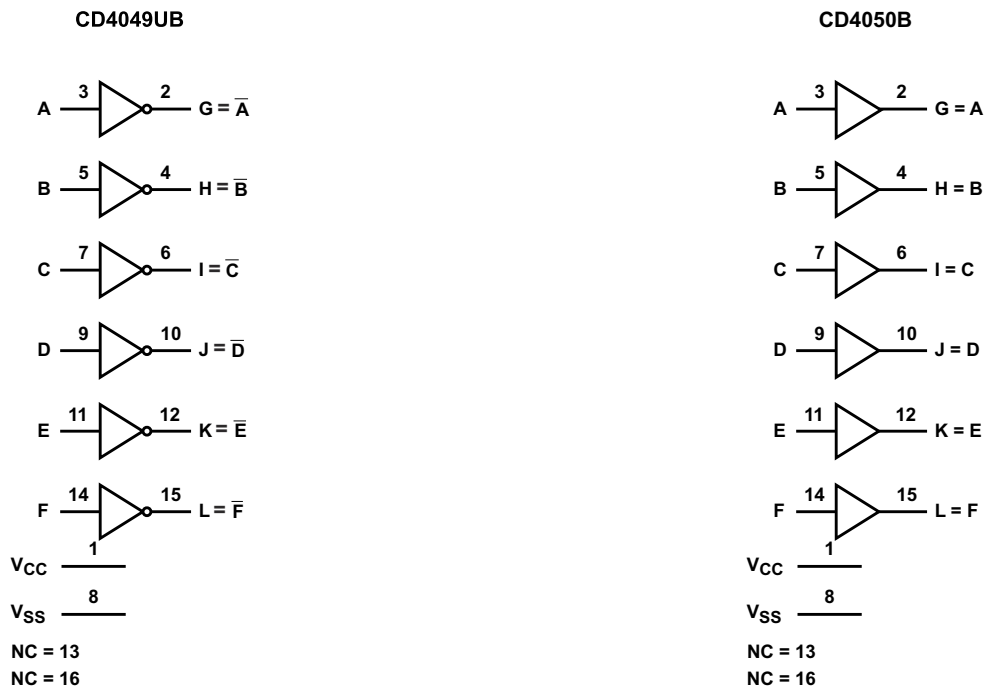

Copyright © 2016, Texas Instruments Incorporated

### 8.3 Feature Description

CD4049UB and CD4050B have standardized symmetrical output characteristics and a wide operating voltage from 3 V to 18 V with quiescent current tested at 20 V. These devices have transition times of  $t_{\text{TLH}} = 40$  ns and  $t_{\text{THL}} = 20$  ns (typical) at 10 V. The operating temperature is from  $-55^{\circ}\text{C}$  to  $125^{\circ}\text{C}$ .

## 8.4 Device Functional Modes

表 8-1 shows the functional modes for CD4049UB. 表 8-2 shows the functional modes for CD4050B.

表 8-1. Function Table for CD4049UB

| INPUT<br>A, B, C, D, E, F | OUTPUT<br>G, H, I, J, K, L |
|---------------------------|----------------------------|
| H                         | L                          |
| L                         | H                          |

表 8-2. Function Table for CD4050B

| INPUT<br>A, B, C, D, E, F | OUTPUT<br>G, H, I, J, K, L |
|---------------------------|----------------------------|
| H                         | H                          |
| L                         | L                          |

## 9 Application and Implementation

### 备注

Information in the following applications sections is not part of the TI component specification, and TI does not warrant its accuracy or completeness. TI's customers are responsible for determining suitability of components for their purposes. Customers should validate and test their design implementation to confirm system functionality.

### 9.1 Application Information

The CD4049UB and CD4050B devices have low input currents of 1  $\mu\text{A}$  at 18 V over full package-temperature range and 100 nA at 18 V, 25°C. These devices have a wide operating voltage from 3 V to 18 V and used in high-voltage applications.

### 9.2 Typical Application



图 9-1. CD4049UB Application

#### 9.2.1 Design Requirements

The CD4049UB device is the industry's highest logic inverter operating at 18 V under recommended conditions. These devices have high sink current capabilities.

#### 9.2.2 Detailed Design Procedure

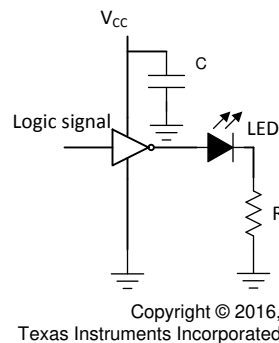
The recommended input conditions for 图 9-1 includes rise time and fall time specifications (see  $\Delta t / \Delta V$  in 节 6.3) and specified high and low levels (see  $V_{IH}$  and  $V_{IL}$  in 节 6.3). Inputs are not overvoltage tolerant and must be below  $V_{CC}$  level because of the presence of input clamp diodes to  $V_{CC}$ .

The recommended output condition for the CD4049UB application includes specific load currents. Load currents must be limited so as to not exceed the total power (continuous current through  $V_{CC}$  or  $GND$ ) for the device. These limits are in the 节 6.1. Outputs must not be pulled above  $V_{CC}$ .

### 9.2.3 Application Curves

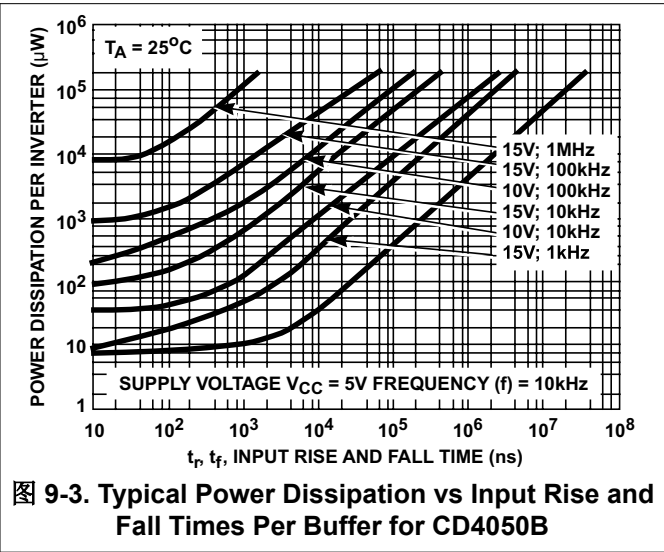
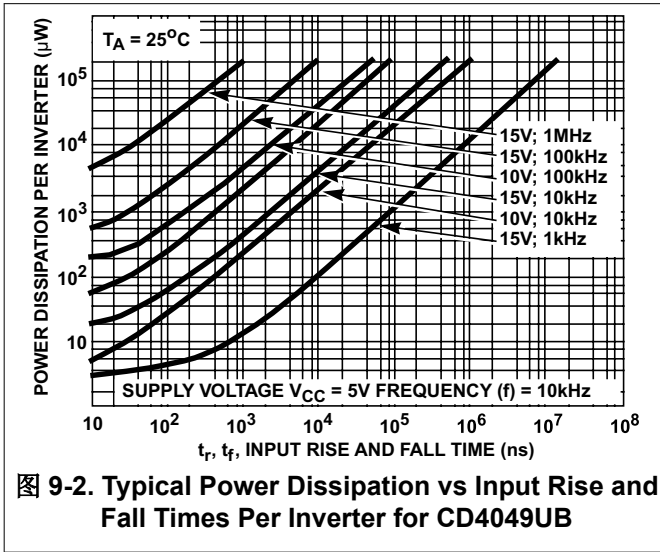

## 10 Power Supply Recommendations

The power supply can be any voltage between the minimum and maximum supply voltage rating in [Recommended Operating Conditions](#).

Each VCC pin must have a good bypass capacitor to prevent power disturbance. For devices with a single supply, TI recommends a 0.1-µF capacitor. If there are multiple VCC pins, then TI recommends a 0.01-µF or 0.022-µF capacitor for each power pin. It is acceptable to parallel multiple bypass capacitors to reject different frequencies of noise. 0.1-µF and 1-µF capacitors are commonly used in parallel. The bypass capacitor must be installed as close to the power pin as possible for best results.

## 11 Layout

### 11.1 Layout Guidelines

When using multiple bit logic devices, inputs must never float.

In many cases, digital logic device functions or parts of these functions are unused (for example, when only two inputs of a triple-input and gate are used, or only 3 of the 4 buffer gates are used). Such input pins must not be left unconnected because the undefined voltages at the outside connections result in undefined operational states. This rule must be observed under all circumstances specified in the next paragraph.

All unused inputs of digital logic devices must be connected to a high or low bias to prevent them from floating. See [Implications of Slow or Floating CMOS Inputs](#) for more information on the effects of floating inputs. The logic level must apply to any particular unused input depending on the function of the device. Generally, they are tied to GND or VCC (whichever is convenient).

### 11.2 Layout Example

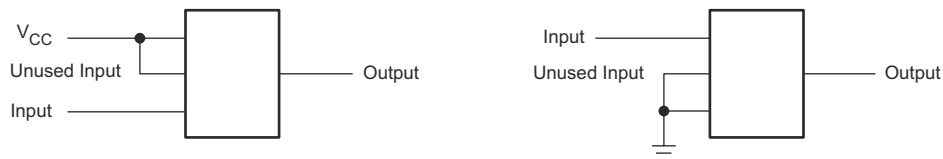

**Figure 11-1. Layout Diagram**



## 12 Device and Documentation Support

### 12.1 Documentation Support

#### 12.1.1 Related Documentation

For related documentation see the following:

[Implications of Slow or Floating CMOS Inputs](#) (SCBA004)

#### 12.2 Related Links

The table below lists quick access links. Categories include technical documents, support and community resources, tools and software, and quick access to sample or buy.

表 12-1. Related Links

| PARTS    | PRODUCT FOLDER             | SAMPLE & BUY               | TECHNICAL DOCUMENTS        | TOOLS & SOFTWARE           | SUPPORT & COMMUNITY        |
|----------|----------------------------|----------------------------|----------------------------|----------------------------|----------------------------|
| CD4049UB | <a href="#">Click here</a> | <a href="#">Click here</a> | <a href="#">Click here</a> | <a href="#">Click here</a> | <a href="#">Click here</a> |
| CD4050B  | <a href="#">Click here</a> | <a href="#">Click here</a> | <a href="#">Click here</a> | <a href="#">Click here</a> | <a href="#">Click here</a> |

#### 12.3 Receiving Notification of Documentation Updates

To receive notification of documentation updates, navigate to the device product folder on ti.com. In the upper right corner, click on *Alert me* to register and receive a weekly digest of any product information that has changed. For change details, review the revision history included in any revised document.

#### 12.4 支持资源

[TI E2E™ 中文支持论坛](#) 是工程师的重要参考资料，可直接从专家处获得快速、经过验证的解答和设计帮助。搜索现有解答或提出自己的问题，获得所需的快速设计帮助。

链接的内容由各个贡献者“按原样”提供。这些内容并不构成 TI 技术规范，并且不一定反映 TI 的观点；请参阅 TI 的[使用条款](#)。

#### 12.5 Trademarks

TI E2E™ is a trademark of Texas Instruments.

所有商标均为其各自所有者的财产。

#### 12.6 静电放电警告



静电放电 (ESD) 会损坏这个集成电路。德州仪器 (TI) 建议通过适当的预防措施处理所有集成电路。如果不遵守正确的处理和安装程序，可能会损坏集成电路。

ESD 的损坏小至导致微小的性能降级，大至整个器件故障。精密的集成电路可能更容易受到损坏，这是因为非常细微的参数更改都可能会导致器件与其发布的规格不相符。

#### 12.7 术语表

[TI 术语表](#) 本术语表列出并解释了术语、首字母缩略词和定义。

## 13 Mechanical, Packaging, and Orderable Information

The following pages include mechanical, packaging, and orderable information. This information is the most current data available for the designated devices. This data is subject to change without notice and revision of this document. For browser-based versions of this data sheet, refer to the left-hand navigation.

**PACKAGING INFORMATION**

| Orderable Device | Status<br>(1) | Package Type | Package Drawing | Pins | Package Qty | Eco Plan<br>(2)  | Lead finish/<br>Ball material<br>(6) | MSL Peak Temp<br>(3) | Op Temp (°C) | Device Marking<br>(4/5) | Samples                 |
|------------------|---------------|--------------|-----------------|------|-------------|------------------|--------------------------------------|----------------------|--------------|-------------------------|-------------------------|
| CD4049UBD        | OBSOLETE      | SOIC         | D               | 16   |             | TBD              | Call TI                              | Call TI              | -55 to 125   | CD4049UBM               |                         |
| CD4049UBDR       | ACTIVE        | SOIC         | D               | 16   | 2500        | RoHS & Green     | NIPDAU                               | Level-1-260C-UNLIM   | -55 to 125   | CD4049UBM               | <a href="#">Samples</a> |
| CD4049UBDRE4     | ACTIVE        | SOIC         | D               | 16   | 2500        | RoHS & Green     | NIPDAU                               | Level-1-260C-UNLIM   | -55 to 125   | CD4049UBM               | <a href="#">Samples</a> |
| CD4049UBDRG4     | ACTIVE        | SOIC         | D               | 16   | 2500        | RoHS & Green     | NIPDAU                               | Level-1-260C-UNLIM   | -55 to 125   | CD4049UBM               | <a href="#">Samples</a> |
| CD4049UBDT       | OBSOLETE      | SOIC         | D               | 16   |             | TBD              | Call TI                              | Call TI              | -55 to 125   | CD4049UBM               |                         |
| CD4049UBDW       | ACTIVE        | SOIC         | DW              | 16   | 40          | RoHS & Green     | NIPDAU                               | Level-1-260C-UNLIM   | -55 to 125   | CD4049UBM               | <a href="#">Samples</a> |
| CD4049UBDWG4     | ACTIVE        | SOIC         | DW              | 16   | 40          | RoHS & Green     | NIPDAU                               | Level-1-260C-UNLIM   | -55 to 125   | CD4049UBM               | <a href="#">Samples</a> |
| CD4049UBE        | ACTIVE        | PDIP         | N               | 16   | 25          | RoHS & Green     | NIPDAU                               | N / A for Pkg Type   | -55 to 125   | CD4049UBE               | <a href="#">Samples</a> |
| CD4049UBEE4      | ACTIVE        | PDIP         | N               | 16   | 25          | RoHS & Green     | NIPDAU                               | N / A for Pkg Type   | -55 to 125   | CD4049UBE               | <a href="#">Samples</a> |
| CD4049UBF        | ACTIVE        | CDIP         | J               | 16   | 25          | Non-RoHS & Green | SNPB                                 | N / A for Pkg Type   | -55 to 125   | CD4049UBF               | <a href="#">Samples</a> |
| CD4049UBF3A      | ACTIVE        | CDIP         | J               | 16   | 25          | Non-RoHS & Green | SNPB                                 | N / A for Pkg Type   | -55 to 125   | CD4049UBF3A             | <a href="#">Samples</a> |
| CD4049UBNSR      | ACTIVE        | SO           | NS              | 16   | 2000        | RoHS & Green     | NIPDAU                               | Level-1-260C-UNLIM   | -55 to 125   | CD4049UB                | <a href="#">Samples</a> |
| CD4049UBPW       | OBSOLETE      | TSSOP        | PW              | 16   |             | TBD              | Call TI                              | Call TI              | -55 to 125   | CM049UB                 |                         |
| CD4049UBPWR      | ACTIVE        | TSSOP        | PW              | 16   | 2000        | RoHS & Green     | NIPDAU                               | Level-1-260C-UNLIM   | -55 to 125   | CM049UB                 | <a href="#">Samples</a> |
| CD4050BD         | OBSOLETE      | SOIC         | D               | 16   |             | TBD              | Call TI                              | Call TI              | -55 to 125   | CD4050BM                |                         |
| CD4050BDR        | ACTIVE        | SOIC         | D               | 16   | 2500        | RoHS & Green     | NIPDAU                               | Level-1-260C-UNLIM   | -55 to 125   | CD4050BM                | <a href="#">Samples</a> |
| CD4050BDT        | OBSOLETE      | SOIC         | D               | 16   |             | TBD              | Call TI                              | Call TI              | -55 to 125   | CD4050BM                |                         |
| CD4050BDW        | OBSOLETE      | SOIC         | DW              | 16   |             | TBD              | Call TI                              | Call TI              | -55 to 125   | CD4050BM                |                         |
| CD4050BDWR       | ACTIVE        | SOIC         | DW              | 16   | 2000        | RoHS & Green     | NIPDAU                               | Level-1-260C-UNLIM   | -55 to 125   | CD4050BM                | <a href="#">Samples</a> |
| CD4050BE         | ACTIVE        | PDIP         | N               | 16   | 25          | RoHS & Green     | NIPDAU                               | N / A for Pkg Type   | -55 to 125   | CD4050BE                | <a href="#">Samples</a> |
| CD4050BEE4       | ACTIVE        | PDIP         | N               | 16   | 25          | RoHS & Green     | NIPDAU                               | N / A for Pkg Type   | -55 to 125   | CD4050BE                | <a href="#">Samples</a> |

| Orderable Device | Status<br>(1) | Package Type | Package Drawing | Pins | Package Qty | Eco Plan<br>(2)  | Lead finish/<br>Ball material<br>(6) | MSL Peak Temp<br>(3) | Op Temp (°C) | Device Marking<br>(4/5) | Samples                 |
|------------------|---------------|--------------|-----------------|------|-------------|------------------|--------------------------------------|----------------------|--------------|-------------------------|-------------------------|
| CD4050BF         | ACTIVE        | CDIP         | J               | 16   | 25          | Non-RoHS & Green | SNPB                                 | N / A for Pkg Type   | -55 to 125   | CD4050BF                | <a href="#">Samples</a> |
| CD4050BF3A       | ACTIVE        | CDIP         | J               | 16   | 25          | Non-RoHS & Green | SNPB                                 | N / A for Pkg Type   | -55 to 125   | CD4050BF3A              | <a href="#">Samples</a> |
| CD4050BNSR       | ACTIVE        | SO           | NS              | 16   | 2000        | RoHS & Green     | NIPDAU                               | Level-1-260C-UNLIM   | -55 to 125   | CD4050B                 | <a href="#">Samples</a> |
| CD4050BPW        | OBSOLETE      | TSSOP        | PW              | 16   |             | TBD              | Call TI                              | Call TI              | -55 to 125   | CM050B                  |                         |
| CD4050BPWR       | ACTIVE        | TSSOP        | PW              | 16   | 2000        | RoHS & Green     | NIPDAU                               | Level-1-260C-UNLIM   | -55 to 125   | CM050B                  | <a href="#">Samples</a> |
| JM38510/05553BEA | ACTIVE        | CDIP         | J               | 16   | 25          | Non-RoHS & Green | SNPB                                 | N / A for Pkg Type   | -55 to 125   | JM38510/<br>05553BEA    | <a href="#">Samples</a> |
| JM38510/05554BEA | ACTIVE        | CDIP         | J               | 16   | 25          | Non-RoHS & Green | SNPB                                 | N / A for Pkg Type   | -55 to 125   | JM38510/<br>05554BEA    | <a href="#">Samples</a> |
| M38510/05553BEA  | ACTIVE        | CDIP         | J               | 16   | 25          | Non-RoHS & Green | SNPB                                 | N / A for Pkg Type   | -55 to 125   | JM38510/<br>05553BEA    | <a href="#">Samples</a> |
| M38510/05554BEA  | ACTIVE        | CDIP         | J               | 16   | 25          | Non-RoHS & Green | SNPB                                 | N / A for Pkg Type   | -55 to 125   | JM38510/<br>05554BEA    | <a href="#">Samples</a> |

(1) The marketing status values are defined as follows:

**ACTIVE:** Product device recommended for new designs.

**LIFEBUY:** TI has announced that the device will be discontinued, and a lifetime-buy period is in effect.

**NRND:** Not recommended for new designs. Device is in production to support existing customers, but TI does not recommend using this part in a new design.

**PREVIEW:** Device has been announced but is not in production. Samples may or may not be available.

**OBSOLETE:** TI has discontinued the production of the device.

(2) **RoHS:** TI defines "RoHS" to mean semiconductor products that are compliant with the current EU RoHS requirements for all 10 RoHS substances, including the requirement that RoHS substance do not exceed 0.1% by weight in homogeneous materials. Where designed to be soldered at high temperatures, "RoHS" products are suitable for use in specified lead-free processes. TI may reference these types of products as "Pb-Free".

**RoHS Exempt:** TI defines "RoHS Exempt" to mean products that contain lead but are compliant with EU RoHS pursuant to a specific EU RoHS exemption.

**Green:** TI defines "Green" to mean the content of Chlorine (Cl) and Bromine (Br) based flame retardants meet JS709B low halogen requirements of <=1000ppm threshold. Antimony trioxide based flame retardants must also meet the <=1000ppm threshold requirement.

(3) MSL, Peak Temp. - The Moisture Sensitivity Level rating according to the JEDEC industry standard classifications, and peak solder temperature.

(4) There may be additional marking, which relates to the logo, the lot trace code information, or the environmental category on the device.

(5) Multiple Device Markings will be inside parentheses. Only one Device Marking contained in parentheses and separated by a "~" will appear on a device. If a line is indented then it is a continuation of the previous line and the two combined represent the entire Device Marking for that device.

(6) Lead finish/Ball material - Orderable Devices may have multiple material finish options. Finish options are separated by a vertical ruled line. Lead finish/Ball material values may wrap to two lines if the finish value exceeds the maximum column width.

**Important Information and Disclaimer:**The information provided on this page represents TI's knowledge and belief as of the date that it is provided. TI bases its knowledge and belief on information provided by third parties, and makes no representation or warranty as to the accuracy of such information. Efforts are underway to better integrate information from third parties. TI has taken and continues to take reasonable steps to provide representative and accurate information but may not have conducted destructive testing or chemical analysis on incoming materials and chemicals. TI and TI suppliers consider certain information to be proprietary, and thus CAS numbers and other limited information may not be available for release.

In no event shall TI's liability arising out of such information exceed the total purchase price of the TI part(s) at issue in this document sold by TI to Customer on an annual basis.

**OTHER QUALIFIED VERSIONS OF CD4049UB, CD4049UB-MIL, CD4050B, CD4050B-MIL :**

- Catalog : [CD4049UB](#), [CD4050B](#)
- Military : [CD4049UB-MIL](#), [CD4050B-MIL](#)

NOTE: Qualified Version Definitions:

- Catalog - TI's standard catalog product
- Military - QML certified for Military and Defense Applications

**TAPE AND REEL INFORMATION**

**QUADRANT ASSIGNMENTS FOR PIN 1 ORIENTATION IN TAPE**

\*All dimensions are nominal

| Device      | Package Type | Package Drawing | Pins | SPQ  | Reel Diameter (mm) | Reel Width W1 (mm) | A0 (mm) | B0 (mm) | K0 (mm) | P1 (mm) | W (mm) | Pin1 Quadrant |
|-------------|--------------|-----------------|------|------|--------------------|--------------------|---------|---------|---------|---------|--------|---------------|
| CD4049UBDR  | SOIC         | D               | 16   | 2500 | 330.0              | 16.4               | 6.5     | 10.3    | 2.1     | 8.0     | 16.0   | Q1            |
| CD4049UBNSR | SO           | NS              | 16   | 2000 | 330.0              | 16.4               | 8.45    | 10.55   | 2.5     | 12.0    | 16.2   | Q1            |
| CD4049UBPWR | TSSOP        | PW              | 16   | 2000 | 330.0              | 12.4               | 6.9     | 5.6     | 1.6     | 8.0     | 12.0   | Q1            |
| CD4050BDR   | SOIC         | D               | 16   | 2500 | 330.0              | 16.4               | 6.5     | 10.3    | 2.1     | 8.0     | 16.0   | Q1            |
| CD4050BDWR  | SOIC         | DW              | 16   | 2000 | 330.0              | 16.4               | 10.75   | 10.7    | 2.7     | 12.0    | 16.0   | Q1            |
| CD4050BNSR  | SO           | NS              | 16   | 2000 | 330.0              | 16.4               | 8.45    | 10.55   | 2.5     | 12.0    | 16.2   | Q1            |
| CD4050BPWR  | TSSOP        | PW              | 16   | 2000 | 330.0              | 12.4               | 6.9     | 5.6     | 1.6     | 8.0     | 12.0   | Q1            |

**TAPE AND REEL BOX DIMENSIONS**

\*All dimensions are nominal

| Device      | Package Type | Package Drawing | Pins | SPQ  | Length (mm) | Width (mm) | Height (mm) |
|-------------|--------------|-----------------|------|------|-------------|------------|-------------|
| CD4049UBDR  | SOIC         | D               | 16   | 2500 | 353.0       | 353.0      | 32.0        |
| CD4049UBNSR | SO           | NS              | 16   | 2000 | 367.0       | 367.0      | 38.0        |
| CD4049UBPWR | TSSOP        | PW              | 16   | 2000 | 356.0       | 356.0      | 35.0        |
| CD4050BDR   | SOIC         | D               | 16   | 2500 | 353.0       | 353.0      | 32.0        |
| CD4050BDWR  | SOIC         | DW              | 16   | 2000 | 350.0       | 350.0      | 43.0        |
| CD4050BNSR  | SO           | NS              | 16   | 2000 | 356.0       | 356.0      | 35.0        |
| CD4050BPWR  | TSSOP        | PW              | 16   | 2000 | 356.0       | 356.0      | 35.0        |

**TUBE**

\*All dimensions are nominal

| Device       | Package Name | Package Type | Pins | SPQ | L (mm) | W (mm) | T (μm) | B (mm) |
|--------------|--------------|--------------|------|-----|--------|--------|--------|--------|
| CD4049UBDW   | DW           | SOIC         | 16   | 40  | 506.98 | 12.7   | 4826   | 6.6    |
| CD4049UBDWG4 | DW           | SOIC         | 16   | 40  | 506.98 | 12.7   | 4826   | 6.6    |
| CD4049UBE    | N            | PDIP         | 16   | 25  | 506    | 13.97  | 11230  | 4.32   |
| CD4049UBE    | N            | PDIP         | 16   | 25  | 506    | 13.97  | 11230  | 4.32   |
| CD4049UBEE4  | N            | PDIP         | 16   | 25  | 506    | 13.97  | 11230  | 4.32   |
| CD4049UBEE4  | N            | PDIP         | 16   | 25  | 506    | 13.97  | 11230  | 4.32   |
| CD4050BE     | N            | PDIP         | 16   | 25  | 506    | 13.97  | 11230  | 4.32   |
| CD4050BE     | N            | PDIP         | 16   | 25  | 506    | 13.97  | 11230  | 4.32   |
| CD4050BEE4   | N            | PDIP         | 16   | 25  | 506    | 13.97  | 11230  | 4.32   |
| CD4050BEE4   | N            | PDIP         | 16   | 25  | 506    | 13.97  | 11230  | 4.32   |

D (R-PDSO-G16)

PLASTIC SMALL OUTLINE



4040047-6/M 06/11

- NOTES:
- A. All linear dimensions are in inches (millimeters).
  - B. This drawing is subject to change without notice.
  - C. Body length does not include mold flash, protrusions, or gate burrs. Mold flash, protrusions, or gate burrs shall not exceed 0.006 (0,15) each side.
  - D. Body width does not include interlead flash. Interlead flash shall not exceed 0.017 (0,43) each side.
  - E. Reference JEDEC MS-012 variation AC.





4220204/A 02/2017

NOTES:

1. All linear dimensions are in millimeters. Any dimensions in parenthesis are for reference only. Dimensioning and tolerancing per ASME Y14.5M.
2. This drawing is subject to change without notice.
3. This dimension does not include mold flash, protrusions, or gate burrs. Mold flash, protrusions, or gate burrs shall not exceed 0.15 mm per side.
4. This dimension does not include interlead flash. Interlead flash shall not exceed 0.25 mm per side.
5. Reference JEDEC registration MO-153.

# EXAMPLE BOARD LAYOUT

PW0016A

TSSOP - 1.2 mm max height

SMALL OUTLINE PACKAGE



LAND PATTERN EXAMPLE  
EXPOSED METAL SHOWN  
SCALE: 10X



SOLDER MASK DETAILS

4220204/A 02/2017

NOTES: (continued)

- 6. Publication IPC-7351 may have alternate designs.
- 7. Solder mask tolerances between and around signal pads can vary based on board fabrication site.

# EXAMPLE STENCIL DESIGN

PW0016A

TSSOP - 1.2 mm max height

SMALL OUTLINE PACKAGE



SOLDER PASTE EXAMPLE  
BASED ON 0.125 mm THICK STENCIL  
SCALE: 10X

4220204/A 02/2017

NOTES: (continued)

8. Laser cutting apertures with trapezoidal walls and rounded corners may offer better paste release. IPC-7525 may have alternate design recommendations.
9. Board assembly site may have different recommendations for stencil design.

## MECHANICAL DATA

NS (R-PDSO-G\*\*)

PLASTIC SMALL-OUTLINE PACKAGE

14-PINS SHOWN



- NOTES:
- A. All linear dimensions are in millimeters.
  - B. This drawing is subject to change without notice.
  - C. Body dimensions do not include mold flash or protrusion, not to exceed 0,15.

## GENERIC PACKAGE VIEW

**DW 16**

**SOIC - 2.65 mm max height**

7.5 x 10.3, 1.27 mm pitch

SMALL OUTLINE INTEGRATED CIRCUIT

This image is a representation of the package family, actual package may vary.  
Refer to the product data sheet for package details.



4224780/A



DW0016A

# PACKAGE OUTLINE

SOIC - 2.65 mm max height

SOIC



4220721/A 07/2016

NOTES:

1. All linear dimensions are in millimeters. Dimensions in parenthesis are for reference only. Dimensioning and tolerancing per ASME Y14.5M.
2. This drawing is subject to change without notice.
3. This dimension does not include mold flash, protrusions, or gate burrs. Mold flash, protrusions, or gate burrs shall not exceed 0.15 mm, per side.
4. This dimension does not include interlead flash. Interlead flash shall not exceed 0.25 mm, per side.
5. Reference JEDEC registration MS-013.

# EXAMPLE BOARD LAYOUT

DW0016A

SOIC - 2.65 mm max height

SOIC



LAND PATTERN EXAMPLE  
SCALE:7X



SOLDER MASK DETAILS

4220721/A 07/2016

NOTES: (continued)

6. Publication IPC-7351 may have alternate designs.

7. Solder mask tolerances between and around signal pads can vary based on board fabrication site.

# EXAMPLE STENCIL DESIGN

DW0016A

SOIC - 2.65 mm max height

SOIC



SOLDER PASTE EXAMPLE  
BASED ON 0.125 mm THICK STENCIL  
SCALE:7X

4220721/A 07/2016

NOTES: (continued)

8. Laser cutting apertures with trapezoidal walls and rounded corners may offer better paste release. IPC-7525 may have alternate design recommendations.
9. Board assembly site may have different recommendations for stencil design.



J (R-GDIP-T\*\*)

14 LEADS SHOWN

CERAMIC DUAL IN-LINE PACKAGE



| DIM \ PINS ** | 14                     | 16                     | 18                     | 20                     |
|---------------|------------------------|------------------------|------------------------|------------------------|
| A             | 0.300<br>(7,62)<br>BSC | 0.300<br>(7,62)<br>BSC | 0.300<br>(7,62)<br>BSC | 0.300<br>(7,62)<br>BSC |
| B MAX         | 0.785<br>(19,94)       | .840<br>(21,34)        | 0.960<br>(24,38)       | 1.060<br>(26,92)       |
| B MIN         | —                      | —                      | —                      | —                      |
| C MAX         | 0.300<br>(7,62)        | 0.300<br>(7,62)        | 0.310<br>(7,87)        | 0.300<br>(7,62)        |
| C MIN         | 0.245<br>(6,22)        | 0.245<br>(6,22)        | 0.220<br>(5,59)        | 0.245<br>(6,22)        |



4040083/F 03/03

- NOTES:
- All linear dimensions are in inches (millimeters).
  - This drawing is subject to change without notice.
  - This package is hermetically sealed with a ceramic lid using glass frit.
  - Index point is provided on cap for terminal identification only on press ceramic glass frit seal only.
  - Falls within MIL STD 1835 GDIP1-T14, GDIP1-T16, GDIP1-T18 and GDIP1-T20.

N (R-PDIP-T\*\*)

PLASTIC DUAL-IN-LINE PACKAGE

16 PINS SHOWN



- NOTES:
- A. All linear dimensions are in inches (millimeters).
  - B. This drawing is subject to change without notice.
  - C Falls within JEDEC MS-001, except 18 and 20 pin minimum body length (Dim A).
  - D The 20 pin end lead shoulder width is a vendor option, either half or full width.

4040049/E 12/2002



# PACKAGE OUTLINE

## NS0016A

### SOP - 2.00 mm max height

SOP



4220735/A 12/2021

#### NOTES:

1. All linear dimensions are in millimeters. Dimensions in parenthesis are for reference only. Dimensioning and tolerancing per ASME Y14.5M.
2. This drawing is subject to change without notice.
3. This dimension does not include mold flash, protrusions, or gate burrs. Mold flash, protrusions, or gate burrs shall not exceed 0.15 mm, per side.
4. This dimension does not include interlead flash. Interlead flash shall not exceed 0.25 mm, per side.

# EXAMPLE BOARD LAYOUT

NS0016A

SOP - 2.00 mm max height

SOP



4220735/A 12/2021

NOTES: (continued)

5. Publication IPC-7351 may have alternate designs.

6. Solder mask tolerances between and around signal pads can vary based on board fabrication site.

# EXAMPLE STENCIL DESIGN

NS0016A

SOP - 2.00 mm max height

SOP



SOLDER PASTE EXAMPLE  
BASED ON 0.125 mm THICK STENCIL  
SCALE:7X

4220735/A 12/2021

NOTES: (continued)

7. Laser cutting apertures with trapezoidal walls and rounded corners may offer better paste release. IPC-7525 may have alternate design recommendations.
8. Board assembly site may have different recommendations for stencil design.

## 重要声明和免责声明

TI“按原样”提供技术和可靠性数据（包括数据表）、设计资源（包括参考设计）、应用或其他设计建议、网络工具、安全信息和其他资源，不保证没有瑕疵且不做任何明示或暗示的担保，包括但不限于对适销性、某特定用途方面的适用性或不侵犯任何第三方知识产权的暗示担保。

这些资源可供使用 TI 产品进行设计的熟练开发人员使用。您将自行承担以下全部责任：(1) 针对您的应用选择合适的 TI 产品，(2) 设计、验证并测试您的应用，(3) 确保您的应用满足相应标准以及任何其他功能安全、信息安全、监管或其他要求。

这些资源如有变更，恕不另行通知。TI 授权您仅可将这些资源用于研发本资源所述的 TI 产品的应用。严禁对这些资源进行其他复制或展示。您无权使用任何其他 TI 知识产权或任何第三方知识产权。您应全额赔偿因在这些资源的使用中对 TI 及其代表造成的任何索赔、损害、成本、损失和债务，TI 对此概不负责。

TI 提供的产品受 [TI 的销售条款](#) 或 [ti.com](#) 上其他适用条款/TI 产品随附的其他适用条款的约束。TI 提供这些资源并不会扩展或以其他方式更改 TI 针对 TI 产品发布的适用的担保或担保免责声明。

TI 反对并拒绝您可能提出的任何其他或不同的条款。

邮寄地址：Texas Instruments, Post Office Box 655303, Dallas, Texas 75265

Copyright © 2024，德州仪器 (TI) 公司